

# Kendo Equipment Manual



(Please don't illegally copy this book)

# Table of Contents

## Introduction

To do kendo safely..... 2

## 1 . The shinai 竹刀

- 1-1 . The construction of the shinai (weights and lengths) ..... 5
  - How to keep your shinai safe..... 6
  - About the shinai ..... 6
- 1-2 . Disassembly of the shinai..... 8
- 1-3 . Maintenance of the shinai..... 9
- 1-4 . Making a shinai out of used parts.....10
- 1-5 . Fixing the shinai tip..... 11
- 1-6 . Tying the shinai handle..... 12
- 1-7 . Tying the nakayui `thong'..... 15
- 1-8 . Tuba and tubadome..... 16
- 1-9 . How to carry the shinai..... 16
  - Comparing the shinai and bokutou with a katana..... 17

## 2 . The Kendogi ‘ jacket ’ 剣道衣

- 2-1 . The construction of the kendogi .....18
  - Why are the jackets and trousers made of cotton dyed with indigo? ...18
- 2-2 . How to wear the kendogi..... 19
- 2-3 . How to wash the kendogi..... 19
- 2-4 . How to fold the kendogi..... 20

## 3 . The Hakama ‘ trousers ’ 袴

- 3-1 . The construction of the hakama..... 21
  - About the hakama..... 21
- 3-2 . How to wear the hakama..... 22
- 3-3 . How to fold and stow the hakama..... 23
- 3-4 . How to wash the hakama..... 24

## 4 • The tare ‘ waist armor ’ 垂

- 4-1 . The construction of the tare..... 25
  - The nafuda ‘name sack’..... 25
- 4-2 . How to wear the tare ..... 26
- 4-3 . How to keep your tare well..... 26

<b>5 . The do ‘breastplate’ 胴</b>	
5-1 . The construction of the do.....	27
The shokkou.....	28
5-2 . Putting on the do.....	29
5-3 . How to tie the cords – method A ~ D.....	33
5-4 . How to keep your do well .....	33
<b>6 . The men ‘helmet’ 面</b>	
6-1 . The construction of the men .....	34
How to connect the men chikawa.....	35
How to make the men.....	35
6-2 . Putting on the tenugui ‘men towel’ – Method A ~ C.....	36
6-3 . Putting on the men- Method A • B.....	39
6-4 . How to keep your men.....	41
Adjusting the lengths of the men cords.....	41
<b>7 . The kote ‘gauntlets’</b>	
7-1 . The construction of the kote.....	42
7-2 . Putting on the kote.....	43
7-3 . Taking off the kote.....	44
7-4 . How to keep your kote well .....	44
7-5 . Tying the kote cords.....	44
<b>8 . The equipment bag</b>	
8-1 . The construction of the equipment bag.....	47
8-2 . Putting the gear in.....	47
8-3 . Taking the gear out.....	47
Hanging up your gear.....	48
<b>9 . Glossary.....</b>	<b>49</b>
<b>In conclusion .....</b>	<b>51</b>

# Introduction

## To do kendo safely

We have written an easy to understand, illustrated manual to help kendo players can maintain their own equipment.

When you strike with the "shinai", it should look like this:

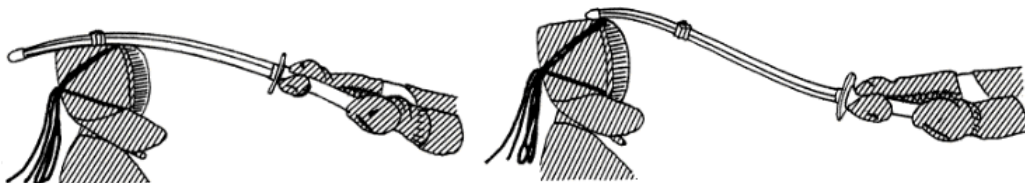

But if your shinai was broken,



But if your shinai has a loose cord,

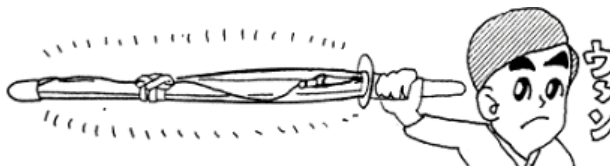

or out of place nakayui, or a loose nakayui

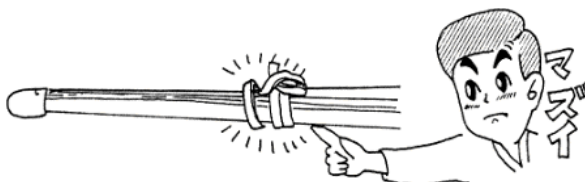

the leather tip may come off the end and the bamboo slats poke someone's eye. People have been blinded like this.



Please read this manual and safely maintain

your shinai and armor.

# 1 . The shinai 竹刀

## 1 - 1 . The construction of the shinai

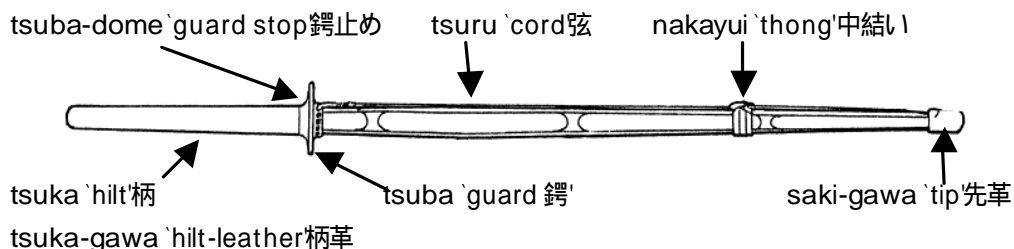

4 shaku (121 cm) length of bamboo is cut 10 cm from the roots. It is then split vertically into 6-8 slats, which will be used to make different length shinai depending on their weight. Four slats with matching joints are chosen and then heated and bent into shape before finally being sanded down to make a single shinai. It is rare for all four slats to come from the same piece of bamboo.

When you chose your shinai , you think about not only length and weight but also balance and types (fat form , fat form , etc. variously :). next;; tsuka-gawa and nakayui and the others.

There are two kinds of leather which is made of these small articles. One is.gintuki leather , this is stronger than the other( toko leather).The gintuki leather has skin's surface.. You would chose gintuki leather.

### Shinai weights and lengths

( see: JKF "Kendo tournaments and judging rules" This is changed on April 1, 1999. )

Length and weight are of a fully constructed shinai, not including the tsuba.  
is minimum diameter of saki-gawa (The unit:cm).

	Sex	Primary School		Junior High School	High School	Adult · Uni-student			
		When using one swords (ittou)						using two swords (ni-tou)	
		the longer	the shorter						
Length	Both	<=99	<=105	<=111	<=114	<=117	<=120	<=114	<=62
Weight	Male	No limit	>=280 g	>=370 g	>=440 g	>=480 g	>=510 g	>=440 g	280 ~ 300
	Female	>=260 g			>=400 g	>=420 g	>=440 g	>=400 g	250 ~ 280
saki-gawa	Male				25	26	26	25	24
	Female				24	25	25	24	24
Nick-name		sabuni 3 "shaku" 2 "sun"	Sabuyon 3 "shaku" 4 "sun"	saburoku 3 "shaku" 6 "sun"	sannana 3 "shaku" 7 "sun"	sanpachi 3 "shaku" 8 "sun"	sanku 3 "shaku" 9 "sun"	sannana 3 "shaku" 7 "sun"	

Note 1: the JKF places no restrictions on weight for primary school students.

Note 2:shaku and sun are old Japanese units, 1 sun = 3.03 cm; 1 shaku = 10 sun.

You must keep your shinai safe !

So after playing KENDO, you must check and maintain your shinai.

To do kendo safely, it is important that your shinai and armor are kept in good condition through regular maintenance. Unless the kendo player (or the parents of young children) understand how the equipment is constructed and how to look after it, it can be dangerous. You need to be careful so that your opponent won't be injured, for example by splinters entering the men or piercing your opponents arm. People have lost their sight and even their life when a cracked piece of bamboo pierced their eyes. People who don't care to look after their shinais but instead treat them with chemicals or use carbon fiber shinais won't develop this spirit. All you need to do is start off with a well shaped shinai and look after it carefully. Instead of checking the diameter you should instead continually check for splinters and splits.

Small Knoeleges

## About the shinai

Two kinds of shinai's bamboo materials

Most of the shinais sold are made of keichiku, a variety of bamboo that grows in warm areas. Bamboo with a diameter of 7-8 cm is harvested throughout the year. Its fibers are more dense and stiff, on the other hand its stiffness means it breaks more easily than madake. In addition, because it may be heated and then rapidly dried at customs inspections it loses its natural moisture and oil which makes it even more likely to split. It is cheaper than Madake bamboo . It grown in regions with large temperature variations in the seasons is denser and more flexible than keichiku bamboo. Four year old bamboo with a diameter of 8-12 cm is harvested from October to February. This bamboo may splinter but does not split easily. Mosochiku (the largest kind of bamboo) looks strong but is inflexible so is not used for making shinais.

When you strike your shinai only once, the bamboo will unfortunately break. So, you should cut the edge of the bamboo, and paint the row, the Vaseline.

And you must remark " Old bamboo is fragile, you must not use " .

## A limit on the diameter of a shinai

JKF put out the guidance indicator for the accident prevention with the bamboo sword on November 10, 1998. The position of nakayui is 1/4 of the total lengths of the bamboo sword the sword ahead, lengths of sakigawa is 50 millimeters or more. "Minimum diameter" of sakigawa (not length with the needlework fee but side which was able to be measured small) was ruled on April 1, 1999.

Shinai gauge was made by all-Japan budogu federation. It is made of plastic, can measure the standard thickness of the shinai. We have three shinai gauges, 24milli (for male under 3.6 and female under 3.7), 25milli (for male 3.7, female 3.8-3.9), 26milli (for male 3.8-3.9).

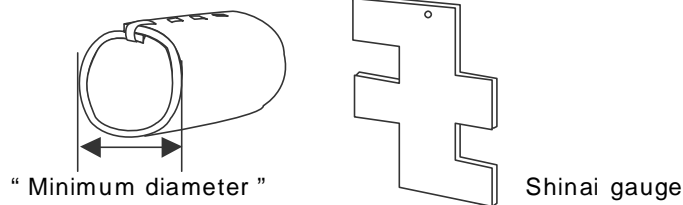

## What makes a good "shinai"?

The most important thing is that it is both strong and flexible. If you put the tip of a shinai on the floor and try to bend it, then it should bend about a third of the way from the tip (around the nakayui), at the place you use to strike your opponent. You should be able to feel it pushing back.

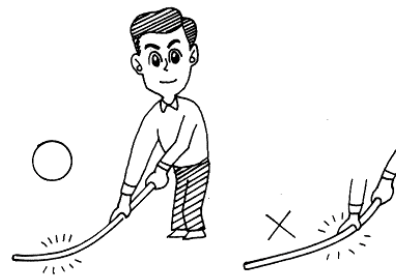

A weak shinai will bend around the guard ("tsuba"). The point at which the shinai bends is the point where it releases power when you strike. When you strike with a weak shina" it will bend like a stick from the tsuba to the tip and then whip back more powerfully than the armor can protect. It can also pierce the "men"-grill and hurt your opponent and may cause you to hurt your own wrists and elbows. Weak shinais have the following characteristics: (1) they bend at the tsuba; (2) they are often planed down to make the handle thin enough; (3) they are often thin at the tip, thick in the middle, and then thin again at the hilt; (4) they tend to be made of less dense bamboo.

Maintaining your shinai while you use it builds up 'samurai spirit' and makes you fully appreciate bamboo.

Bamboo splits and splinters while it is used so requires maintenance.

# 1 - 2 . Disassembly of the shinai

Loosen or untie the nakayui 'leather thong'.



Untie the tsuru 'cord'.

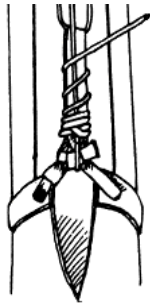

Pull the leather tip (saki-gawa) off with one hand, while holding the bamboo slats together with the other to keep the rubber tip (saki-gomu 先ゴム) in place.

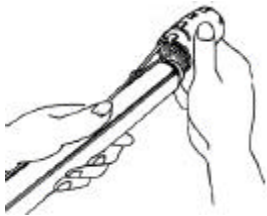

Take off the leather hilt (tsuka-gawa).

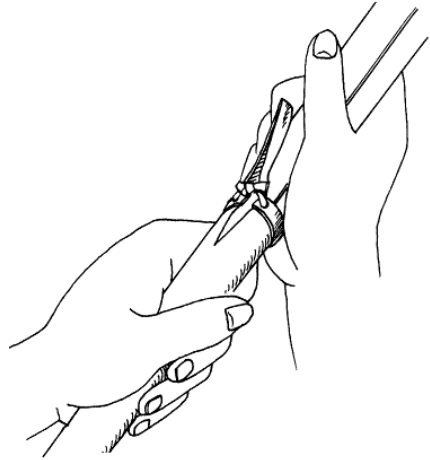

Your shinai should now look like this: (Normally you only need to completely disassemble the shinai to smooth or replace a whole slat.)

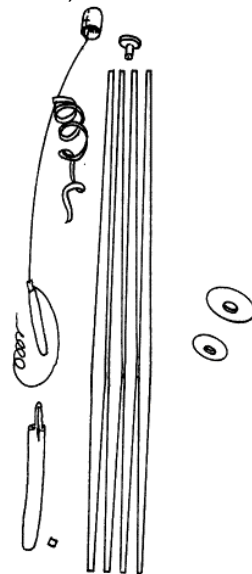



## 1 - 3 . Maintenance of the shinai Removing splinters

When you have some splinters or a small split, take off the nakayui, tsuru and tip as described in section (you may have to completely disassemble the shinai).



Scrape the splinters off with firm strokes from the hilt towards the tip, using a knife, file or a piece of glass. If you scrape from tip to hilt, the blade may dig into the bamboo.

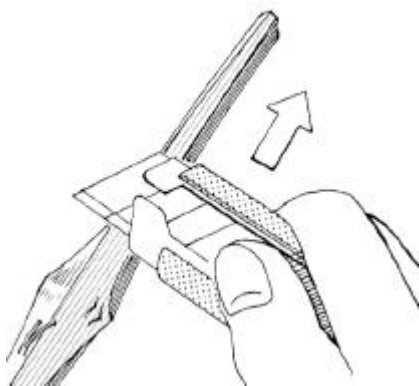

Next use some sandpaper to smooth the surface. Finally rub in a little wax, Vaseline or vegetable oil.

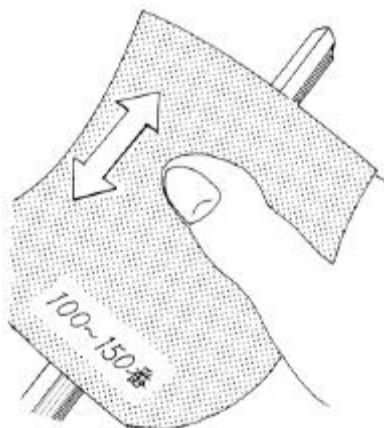

Note: If the bamboo actually splits (with or against the grain) you should stop using it. It is dangerous to tape it up and keep using it.

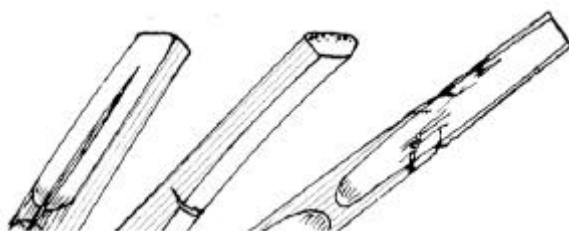

# 1 - 4 . Making a shinai out of used parts

Combining slats from several damaged shinais to make a new one.

Shinai have a small iron plate (called a chigiri) in the handle that keeps the handle together and stops the slats from moving around. It fits into a groove cut in each slat.

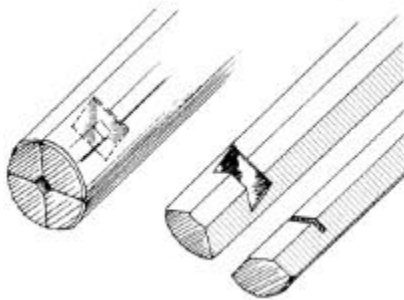

Therefore it is necessary to cut a new set of grooves. Leave the iron plate in the slats it fits then add the new slats and squeeze tightly. The plate should leave a little mark.

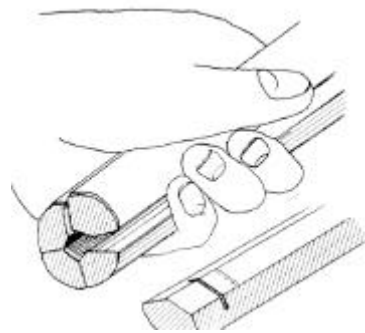

When you use slats from different shinai, the grooves may be in different positions.

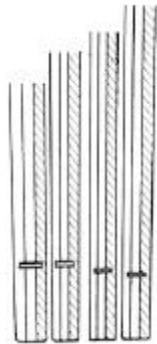

Use a small saw (a hacksaw is fine) to cut a thin groove along this mark.

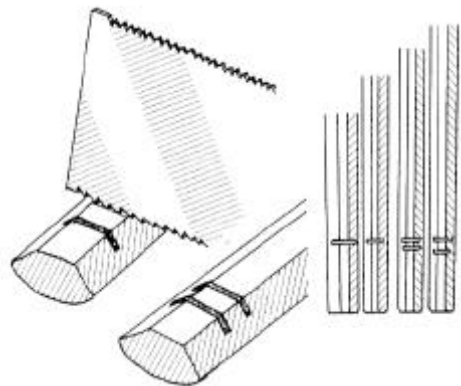

# 1 - 5 . Fixing the *shinai* tip 先革

Fasten the tsuru to the tip (saki-gawa) using a bowline knot.

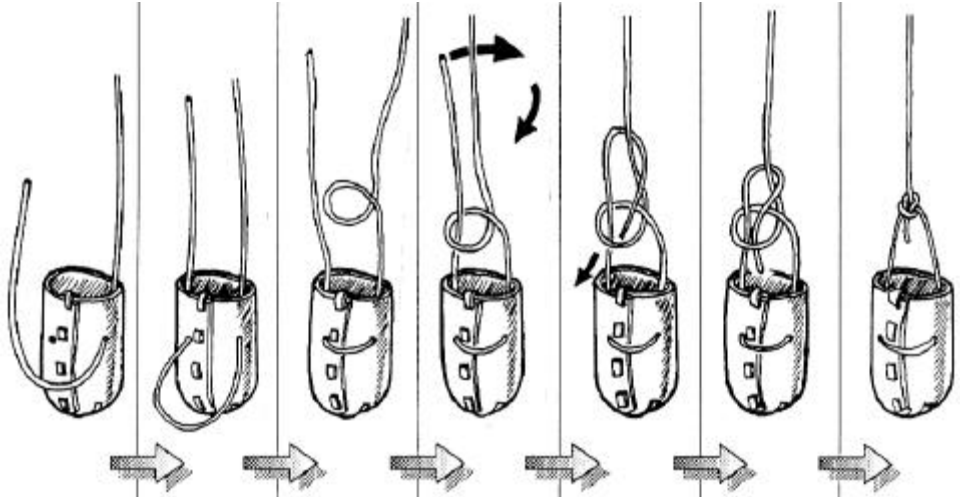

Put the rubber tip ("saki-gomu") in the end. Various diameters of rubber tip are sold, you should use one that just fits in the space left by the bamboo, if it is too small it can be dangerous. Carbon-fiber shinai's have a special kind of rubber tip (actually plastic) which should always be used with them.



Slide the leather tip on.



## The construction of the saki-gawa

The saki-gawa 'leather tip': If the end opens or is holed, get a new one, it cannot safely be repaired.



# 1 - 6 . Tsuru: Tying the shinai handle 弦

tsuru is a bowstring made of a chemical fiber or a silk. Fiber. Silk one needs drawing through to soften by a eyeleter before tying.

First put the hilt leather (tsuka-gawa) on.  
(If the shinai is new it will be held together with string. Take this string off.)



Using a rubber sheet (or gloves) makes it easy!

Pass the cord through the nakayui 'leather thong' (that holds the slats together) and komono 'small leather loop'.

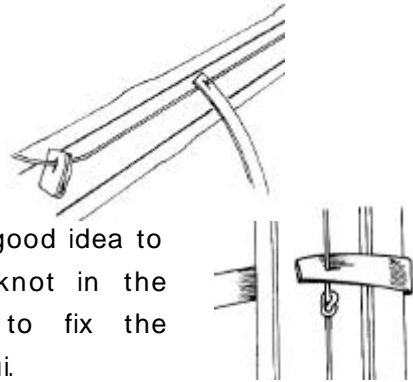

It is a good idea to tie a knot in the tsuru to fix the nakayui.

## How to tie the leather cord

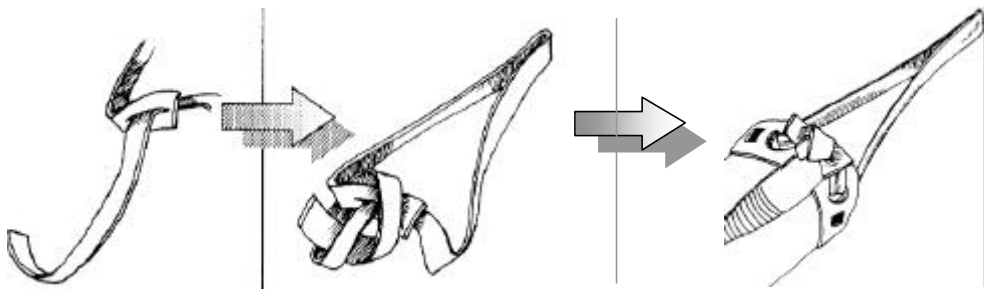

## The construction of the tsuka and to shorten

The hilt (tsuka): Pucker the pommel (tsuka-gashira) and sew it as shown below, then turn it inside out.



To shorten the hilt, cut the end or closest to the guard or cut the other side and do like written in the left.

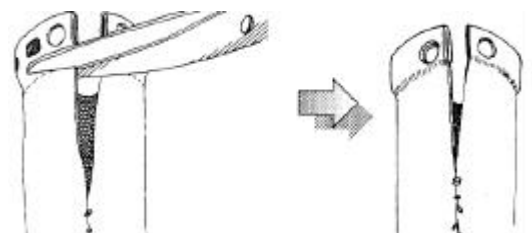

Tie the cord securely round the komono. There are three ways.

A

Through the tsuru  
to the hole of small  
articles



to round in  
surroundings of small  
articles



passes as shown in  
figure



trough edge of  
tuka's frap, return  
to small articles,

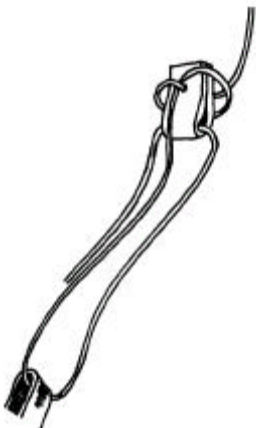

B (琴弦はこの方法で)

Through the tsuru  
to the slit of small  
articles



to round in  
surroundings of small  
articles



passes as shown in  
figure



trough edge of  
tuka's frap, return  
to small articles,

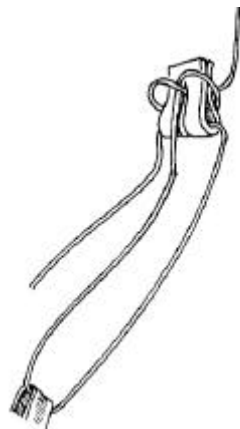

C

Make a circle and



tying



trough edge of  
tuka's frap, return  
to small articles,



Pass the cord through the 'leather loop' on the hilt (kawa-himo); Thread it back through the komono. Pass it under the knot in the hilt's leather loop and pull it tight. Pull the cord taught with your right hand while you hold the komono down with the left.

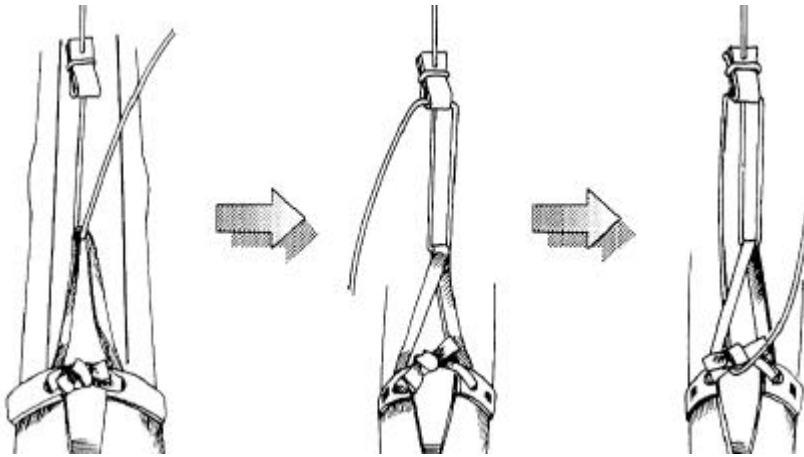

Wrap it round the loop. Tie it once.

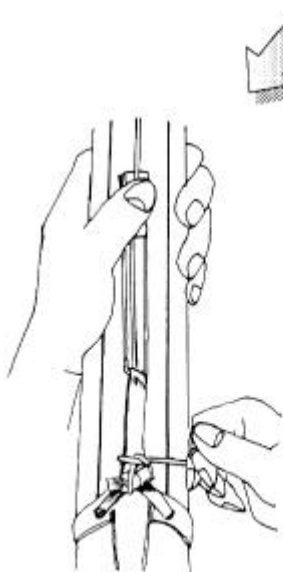
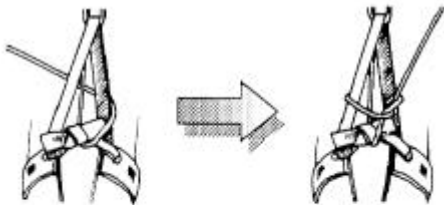

Wrap the cord round the leather loop about seven times.



Finally, use an awl to make a space between the two branches of the loop and pass the cord through.

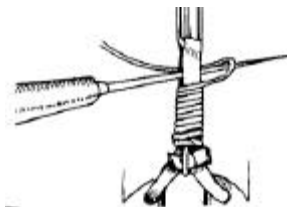

The final version!

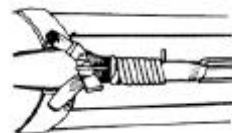

# 1 - 7 . Tying the nakayui 'thong' 中結い

Wrap the nakayui 'thong' thrice round the shinai rough side up.

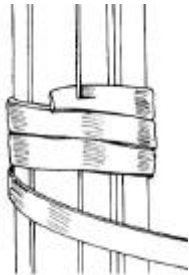

Thread it under the cord and cross it back.



Thread under the tsuru from the other side.

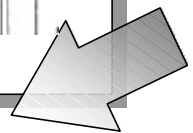

Loop it round and under the last loop.



Again loop it round the tsuru, cross over and pass it under the last loop.



Repeat this once more, then cut off any excess leather.



左右に締まることで、動かなくなります。

What should I do for emergency repairs if the nakayui breaks?

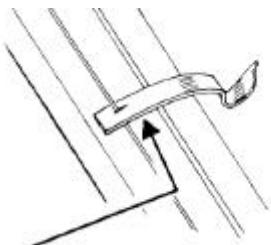

Cut the hole open and take it off.

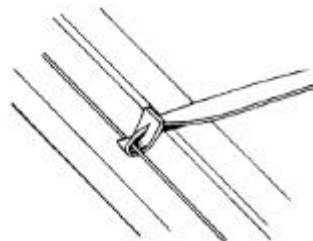

Then make a new hole, attach it as shown and start again.

## 1 - 8 . Tsuba 鐙 (つば) ・ Tuba-dome 鐙止め (つばどめ)

Tsuba is a round one of leather or a chemical product, and within nine centimeters in the diameter. Tsuba is not only for guarding other party's hitting , but also for tying bamboos. The hole of one made of the leather is growing bigger, while using.

Tsuba of the science product is cheaply. You can use any though various color, because JKF does not provide for the color.

You prepare a just good size r the handle of the Shinai. If it's size is not suitable or the corner of the hole of guard is sharp, tsuka would be broken.

About three kinds of Tuba-dome are sold. It is made of rubber.

## 1 - 9 . How to carry the shinai (The shinai bag)

Bags can hold from 1 to 3 "shinai". Some have a shoulder strap. Bags can be made from many materials such as cotton or leather or others , and come in many colors. Feel free to design and make it own!

Because this belt wears out easily, let's treat politely.

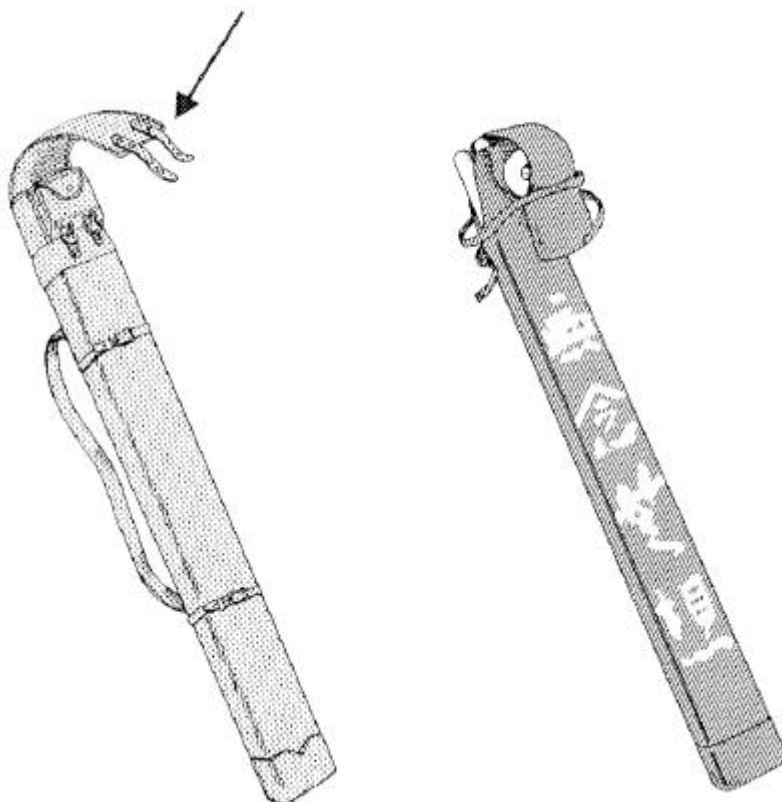



Comparing the bokutou and mogitou with a katana

katana 日本刀、刀

"Sword" is forged iron. It is solid and sharp. It is one of Japanese famous beautiful arts. In japan, registration is obligated by the gun swords method, and the registration certificate is necessary for possession. "honmi" and "shinken" might be called.

The blade is ground well, and there is seldom rusting . When you touch it , you would wipe off with powder of deer's corner, and Japanese paper and paint new oil. It is very expensive to have sharpening. The length is much shorter than bamboo swords. The weight is about one kilogram. There is usages of appreciation, the iai, the battoujutsu, and the kendo-kata, etc. , and it is various as length, weight, shapes of edge, and decoration (handle and sheath).

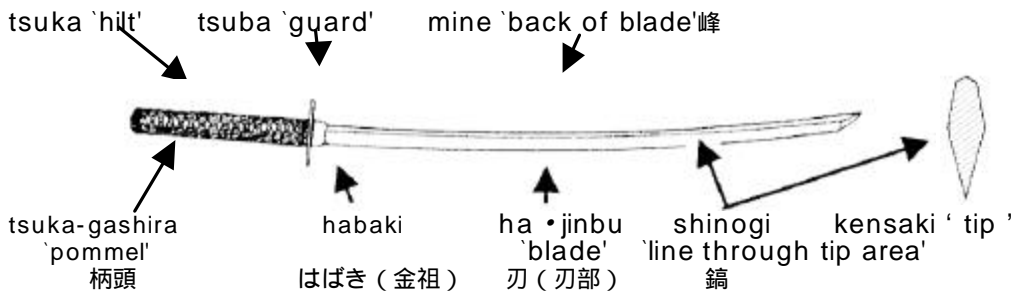

mogitou 模擬刀

Seriousness occasionally substitutes the imitation sword of the alloy such as aluminum because the shinken is expensive. Shape is serious and is just like. The blade is not attached and cannot be cut. But point of blade is harmful. Though it looks strong but it is very fragile. If you had thrown mogitou a hard tree to cut , mogitou breaks as popping

bokutou 木刀

The wooden sword is used instead of a sword and a mock sword to understand the theory of the Nihon-Kendo-Kata. The size also has a large sword for adults, an inside sword for children, and the knife for the kendo type. Additionally, there are the one made only for pretense and the one of various shape by various sects.

The materials of Bokutou are variously, but oak is most suitable because of a little breaking worry.

## 2 . The kendogi ‘ jacket ’ 剣道衣

### 2 - 1 . The construction of the kendogi

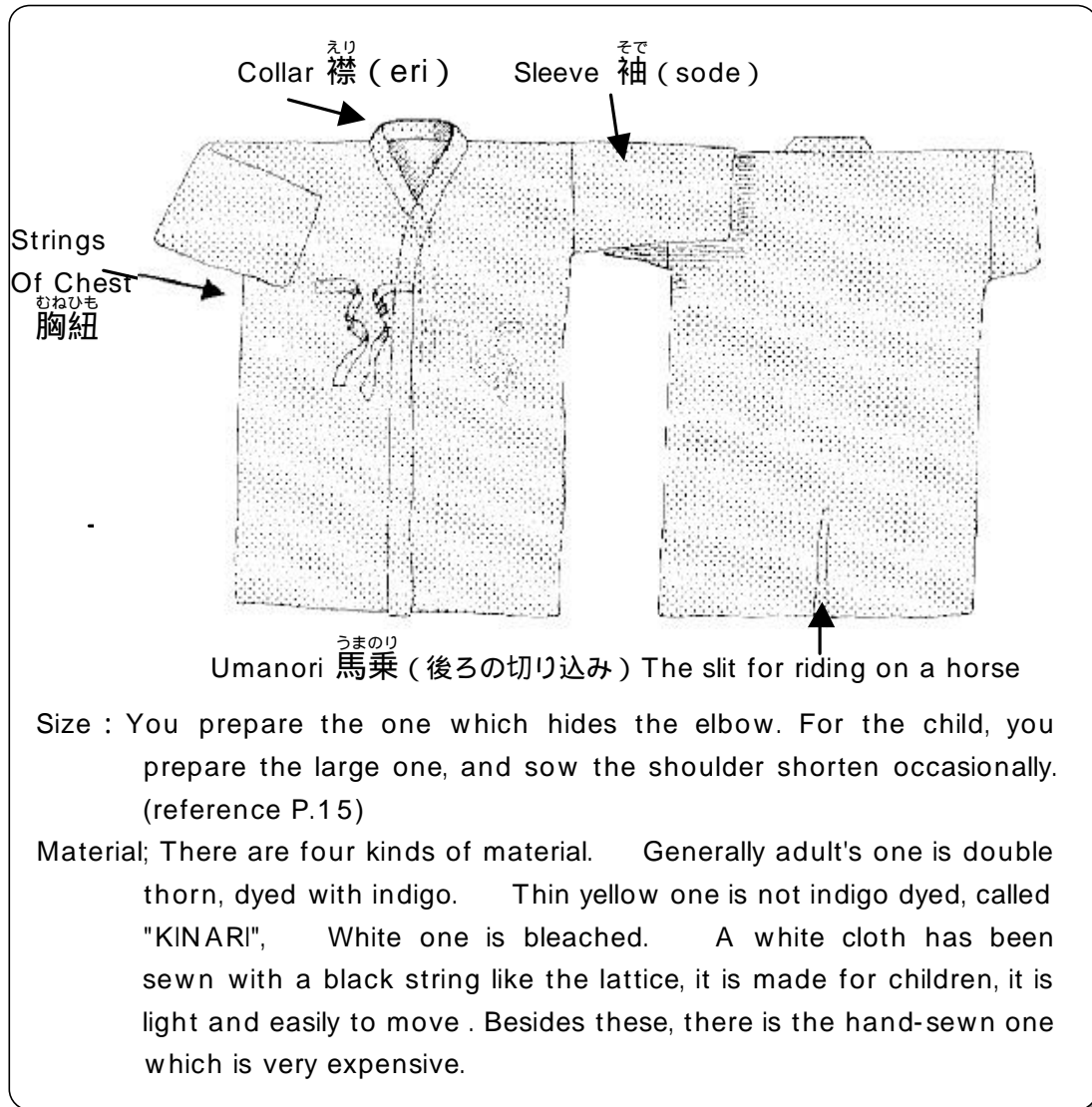

Size : You prepare the one which hides the elbow. For the child, you prepare the large one, and sew the shoulder shorten occasionally. (reference P.15)

Material; There are four kinds of material. Generally adult's one is double thorn, dyed with indigo. Thin yellow one is not indigo dyed, called "KINARI", White one is bleached. A white cloth has been sewn with a black string like the lattice, it is made for children, it is light and easily to move . Besides these, there is the hand-sewn one which is very expensive.

#### Small Knoeleges

Why are the jackets and trousers made of cotton dyed with indigo?

Partly for tradition's sake. However indigo-dyed cotton is also the best choice because it is not easily damaged by sweat, looks nicer the more you use it and is also a mild disinfectant.

## 2 - 2 . How to wear the kendogi

First of all, you connect inside strings. Next, you connect outside strings. You prevent the nape of the neck from opening. Moreover, so as not to wrinkle, you put on length the back.

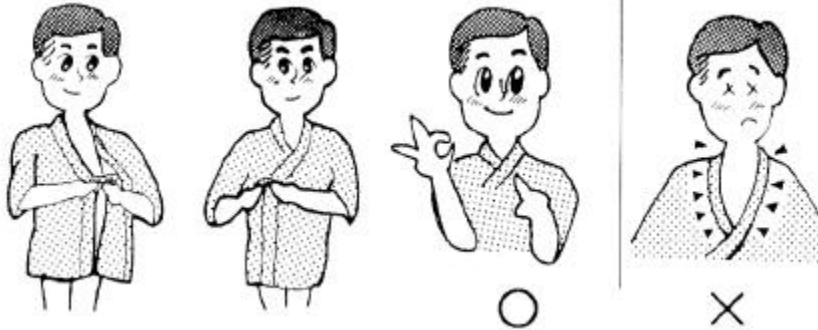

Note: To keep their jackets properly closed, some women use a hook, or velcro, or even tape.



## 2 - 3 . How to wash the kendogi

You might not to wash out the dye it is better to lightly hand wash the clothes in water and quickly dry them rather than to use detergent in a washing machine.

### When child's kendo clothes are large

You apply the sign half of length from the center of the back to the needlework eyes of the shoulder. Length by which you want to shorten the sleeve is assumed to be "a". You weave from the sign ahead and sew half the length of "a".

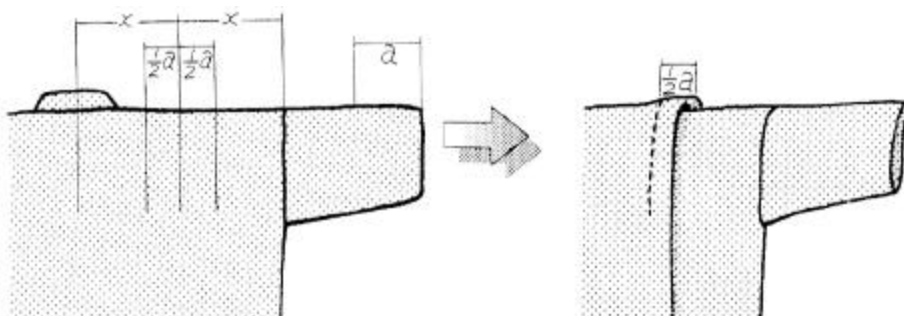

## 2 - 4 . How to fold the kendogi

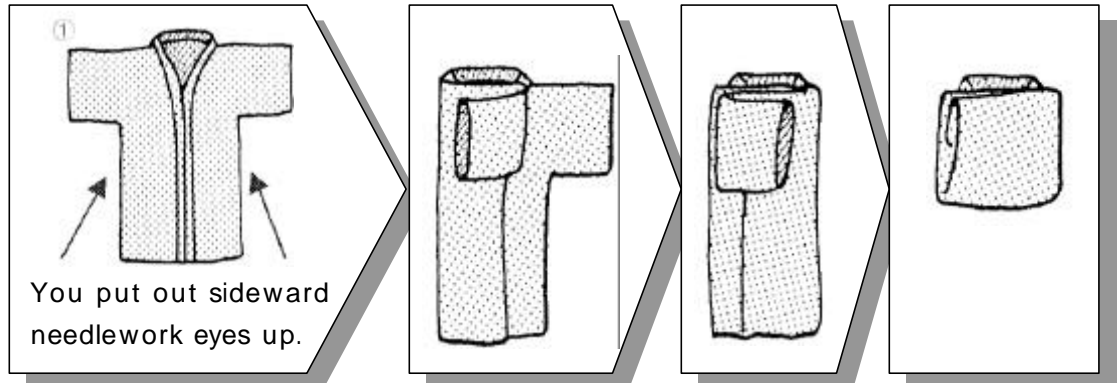

### How to fold Japanese clothes

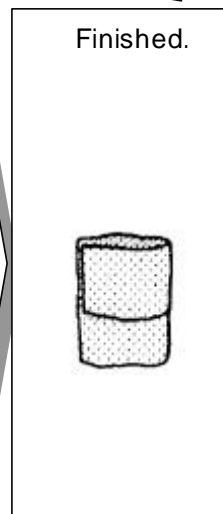
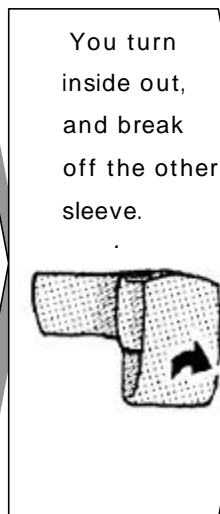
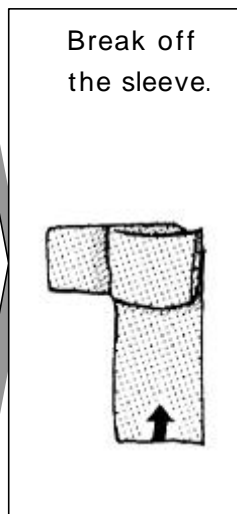
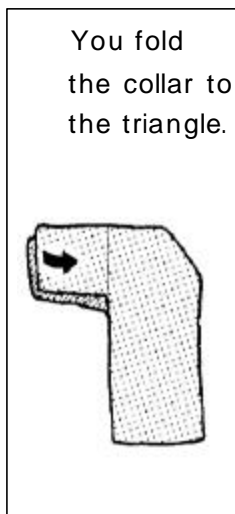
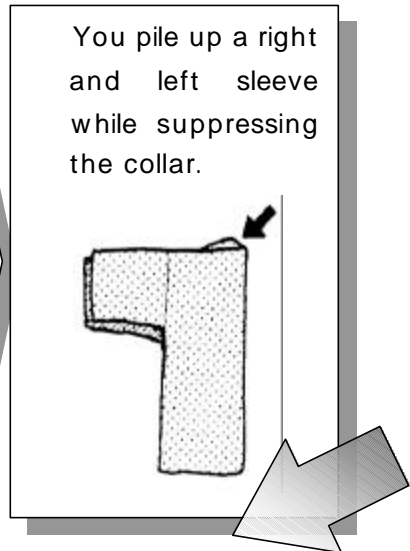
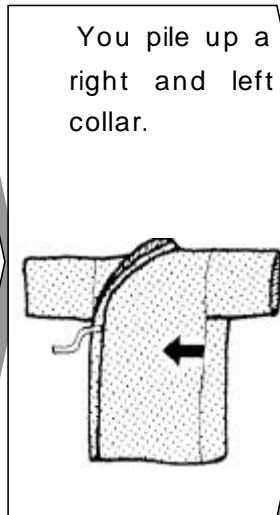
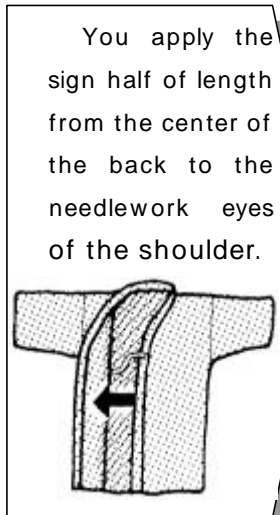

### 3 . The hakama ‘ trousers ’ 袴

#### 3 - 1 . The construction of the hakama

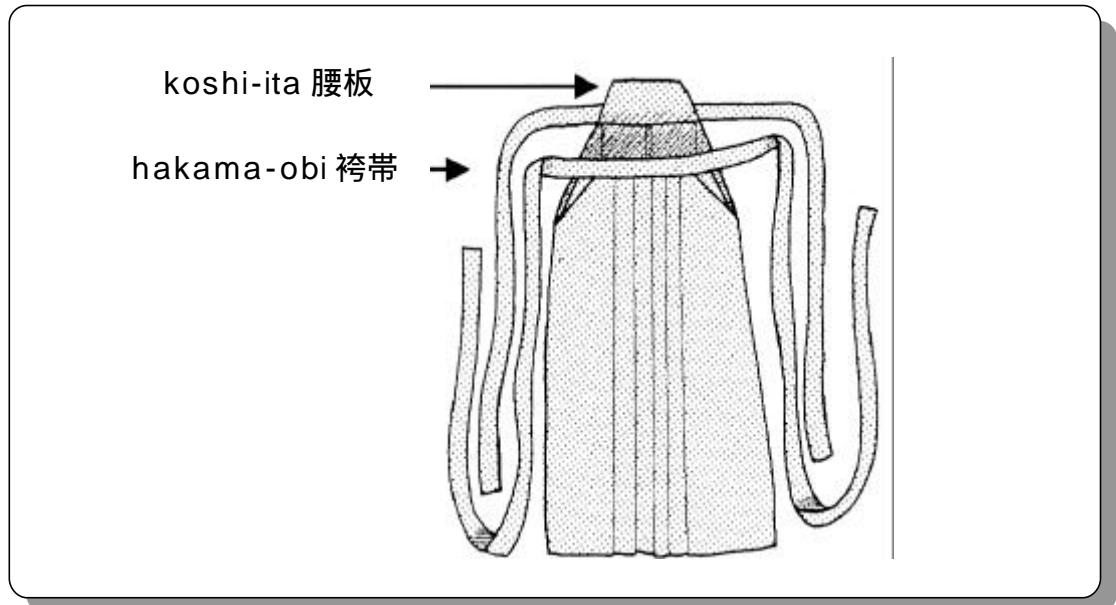

#### Small Knoeedges

#### About the hakama

There are many kinds of hakama: hunting, field, long and short, but only two types are still worn today: men's (horse-riding) and women's (undivided hakama, with no back plate). Wearing a hakama with a stiff back plate straightens your spine, while keeping the collar of your jacket on the back of your neck, pulls your chin in and gives you perfect posture.

A hakama has five pleats in the front and one at the back. The five pleats represent the five Confucian relationships of :righteousness between ruler and minister; affection between father and son; attention to their separate functions between husband and wife; order between elder and younger brothers and faithfulness between friends; as well as the five Confucian virtues of humanity, righteousness, propriety, wisdom and faithfulness. The single pleat reminds us that just as loyalty and filial piety are one and the same we should follow the true path without double dealing. The hakama is designed so that we should think of these things whenever we put it on.

### 3 - 2 . How to wear the hakama

Step into the hakama and hold them to your waist.



Wrap the front sashes (himo) behind you, then cross them in front ...

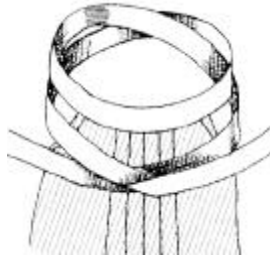

and tie them in a bow behind you.



Slip the peg attached to the koshi-ita into the sashes.

koshi-ita 'back plate'

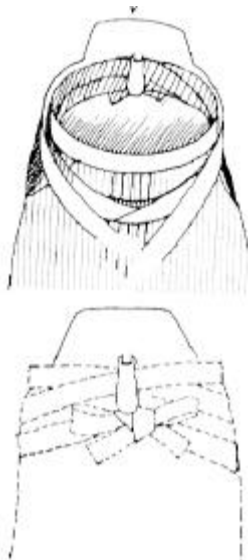

Tie the back sashes in front of you.

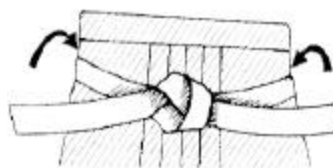
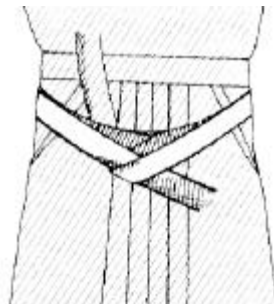

Tuck the extra length of the sashes round the tied ones.

The hem should be lower at the front than the back.



### 3 - 3 . How to fold and stow the hakama

Put the hakamaface down on a flat place such as the floor. Use your right hand to place the right trouser leg, then smooth the back pleat.

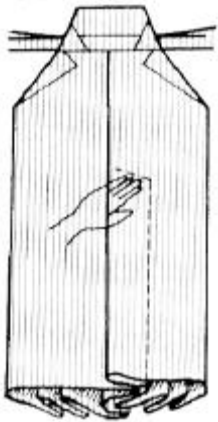

Turn the hakama over, so the front faces up, settle both legs and then stretch it vertically.

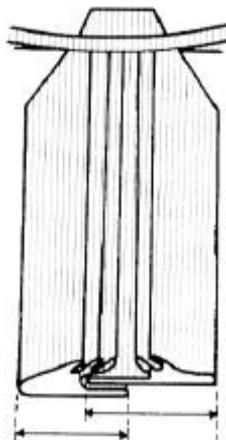

Fold the five pleats so they lie straight.

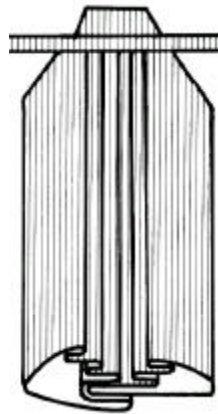

Fold both sides in to the middle, then fold it lengthwise three times.

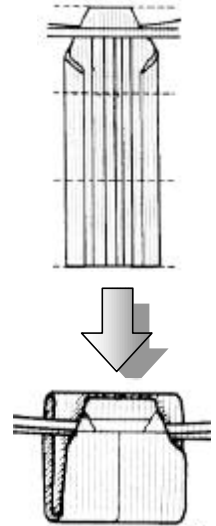

Fold the longer front sashes to a half, then a quarter of their length, and cross them over.

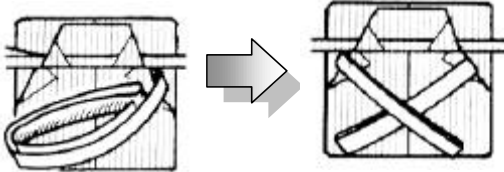

Tie up the shorter front sashes.

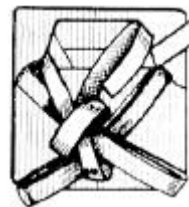

You finished the left side.

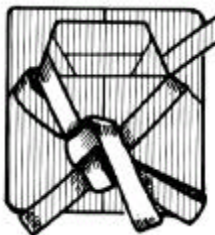

The right is also the same.



You passes through a left string.

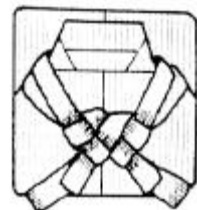

### 3 - 4 . How to wash the hakama

You can machine wash hakama made of synthetic fibers.

If you wash hakama made of indigo-dyed cotton in a machine, the indigo will leach out and the pleats will disappear.

#### How to wash the hakama made of indigo-dyed cotton

Wash the folded hakama in the bathroom, by pressing it under water.

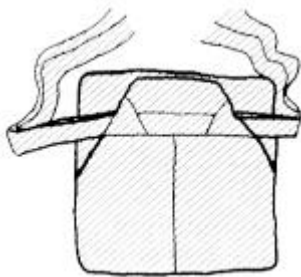

Don't wring it out, just refold it and smooth the water out.

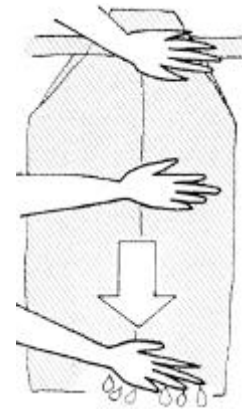

Hang it up to dry upside down, with the pleats in place.

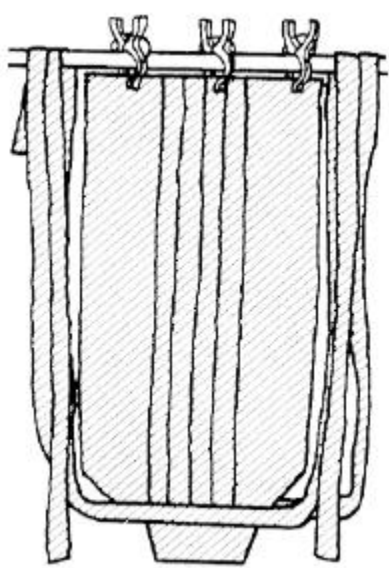

If you wash it like this the pleats won't disappear and will stay wrinkle free. If you spin dry it, it will wrinkle, and if you iron it ,it shines.

After the hakama dries, You fold, put under the square cushion of the chair , and you sits or you presses under the mattress, and the pleat attaches clearly.



## 4 . The tare ‘waist armor’<sup>垂れ</sup>

### 4 - 1 . The construction of the tare

When you pick the stitching ...

wakihimo

脇紐

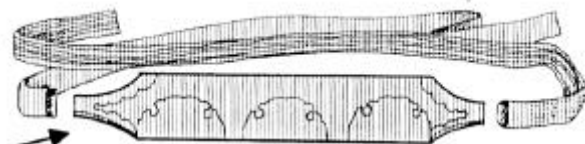

haraobi

‘gut belt’<sup>腹帯</sup>

oodare

‘big flap’<sup>大垂</sup>

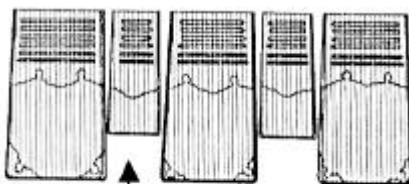

kodare

‘small flap’<sup>小垂</sup>

Each flap is rimmed with leather and then sewn onto the haraobi.



There are many steps of decoration strings in tare, it seems better. More the number of steps of decoration strings is, the more expensive. However, good tare is soft.

Size; It is for adults, for women, and for children (size and smallness).

Material; Piercing by sewing machine or piercing by hand-sewing.

### The nafuda ‘name sack’

The nafuda ‘name sack’, which used to be called the tare mane, is worn on the center flap of the “tare”. It is made from blue or black cloth with white letters stitched or sewn on. The club name is written horizontally across the top, and the individual’s name vertically down the middle. You must wear one when you compete.



## 4 - 2 . How to wear the tare

Kneel in seiza, put the tare on your lap, wrap the cords round behind you



then tie them in a bow under the center flap.

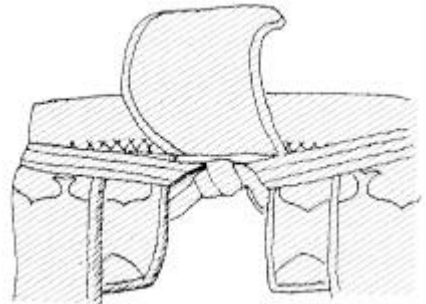

They should cross just under the back plate.

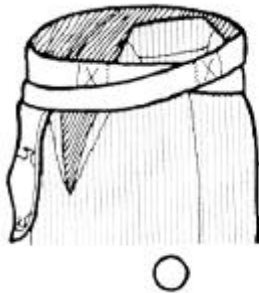

## 4 - 3 . How to keep your tare well .

If you don't keep the cords flat, they will break at the kinks. Iron them occasionally.

Coil the cords round the ends.

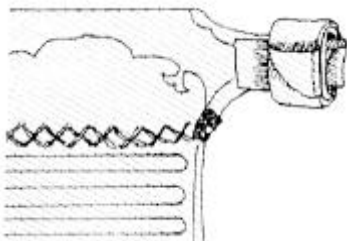

If they are flat , just fold them.

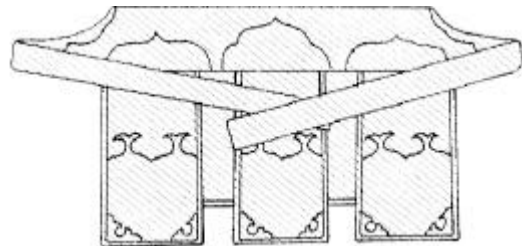

Brush the tare occasionally with a toothbrush.

When the surface wears out, leather etc. are had to be applied before inside bedding ground comes out. When the strings wears out, you must repair.

# 5 . The do 'breastplate' 胴

## 5 - 1 . The construction of the do

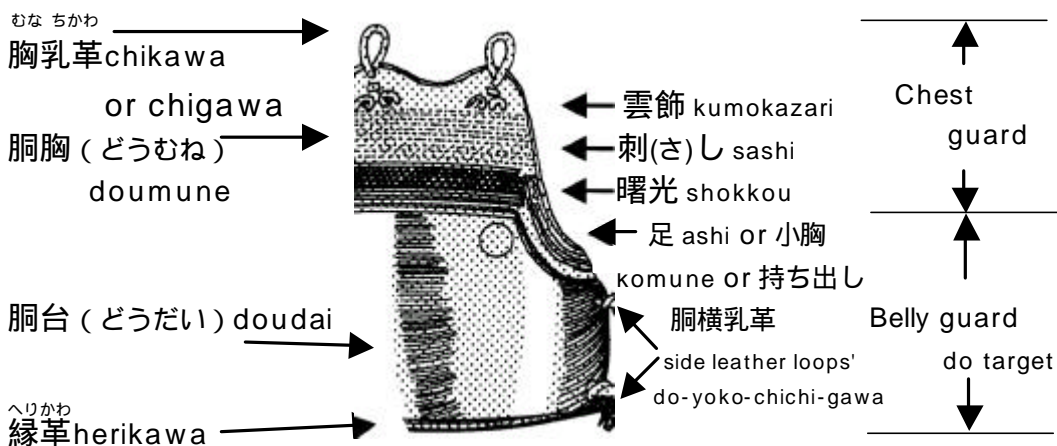

The do is composed of some parts, and it is the combination and there are various one. Ypu will choose in consideration of weight, the decoration, and the price, etc. though the size is suitable, it is not in the function as a protector.

Size; There is a standard for adults, for women, and for children, etc. The size changes in the height of dodai, the height of width and chestguard, and width, etc.

Material; There are three kinds of materials of Belly guard about leather, the nylon resin, "Yamato trunk" or "carbon trunk" and paper "fiber trunk". The dodai of leather is made from strips of heavy bamboos (43、50、60) lashed together with fine bamboos and kite thread. It is then covered with water-buffalo hide and lacquered. There is variously a color. Hardness on the surface is same as the person's fingernail. So It is necessary to note it will be damaged by the one which is harder than the bamboo sword .The belly and chest guards are laced together with two strips of leather.

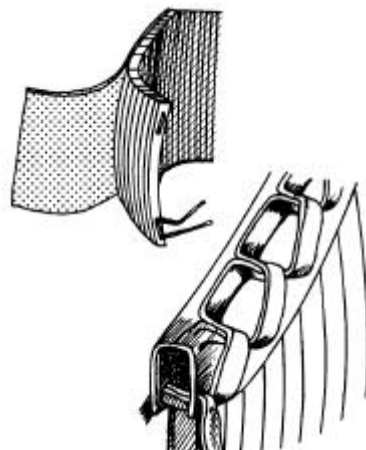

## Fixing the do cords.



## Fixing the do-yoko-chichi-gawa 'side leather loops'

Method of connecting two

The hole of Belly guard



Method of dividing of each in two, and connecting four

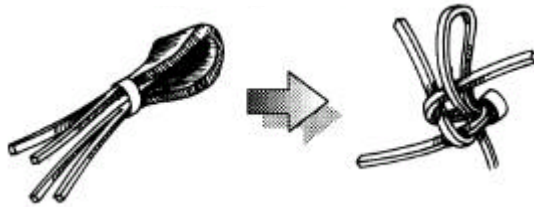

Small Knoeedges

## Shokkou

( Embroidery of the do Chest guard and The tsuki area (the throat flap) of the men 'helmet' )

The Nakanishi Chuzou began to use the bamboo sword and the protector for middle term of Edo. The Shokkou began to be used before long to decorate though the armor in those days did not have the decoration. The shokkou has a variety of patterns and a variety of colors. Not only the one to defend the life only but also beauty Bushi was demanded of armor for having in the Warring State Period of Japan.

## 5 - 2 . Putting on the do

As the do is a target, you have to put it in the proper position, where you can move easily. Don't try to reduce the target area, or protect your ribs or throat from bad cuts and thrusts by tying the do too high.

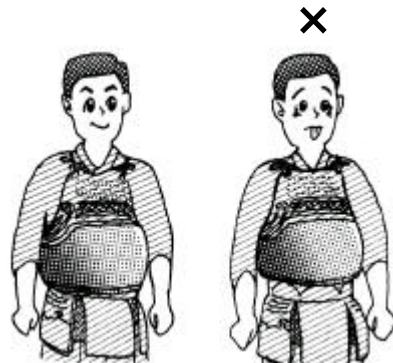

Kneel in seiza, rest the do on your thighs, then cross the long cords behind you and tie them through the leather loops.



Tie the short cords behind you in a bow.

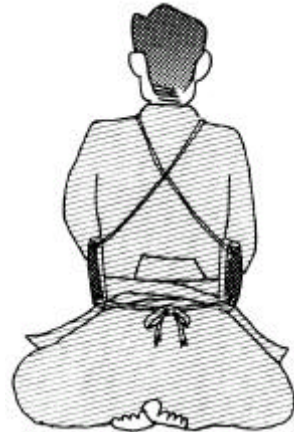

## There are many ways to tie the do.

All that is important is that it is easy to adjust and doesn't come off when you move. Four examples of typical A-D are shown here.

About undermentioned A and B, I show you two aspects, which are from the front and from me.

A



B



C



D



# How to tie the cords - method • A

Seen from in front

Seen from your point of view

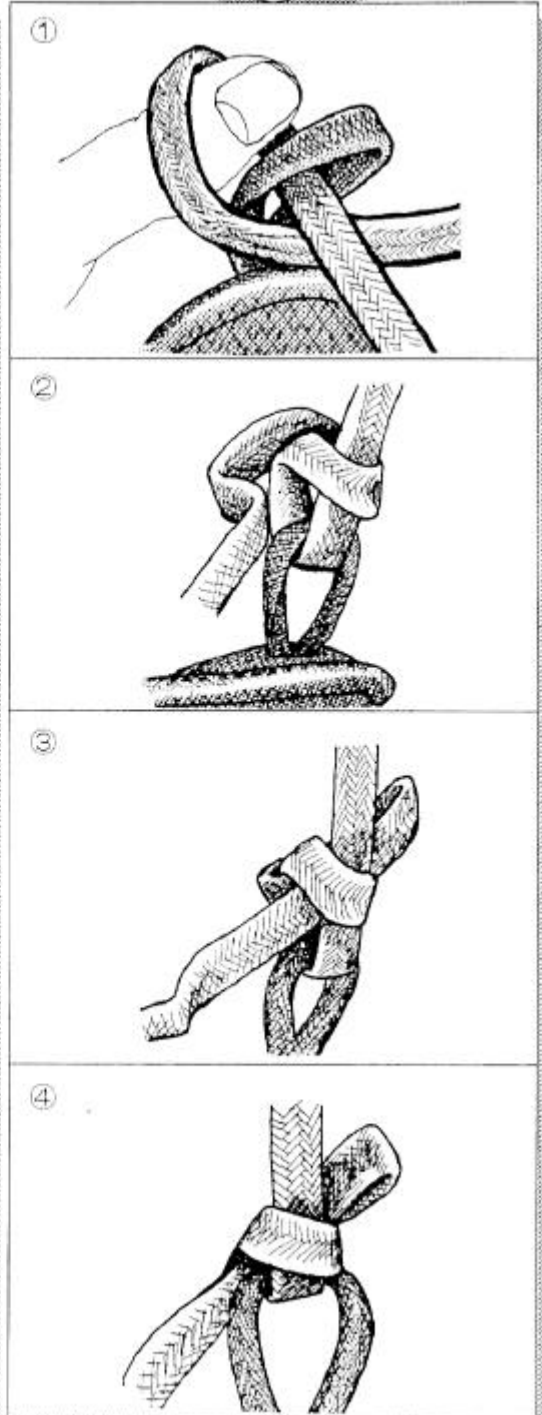
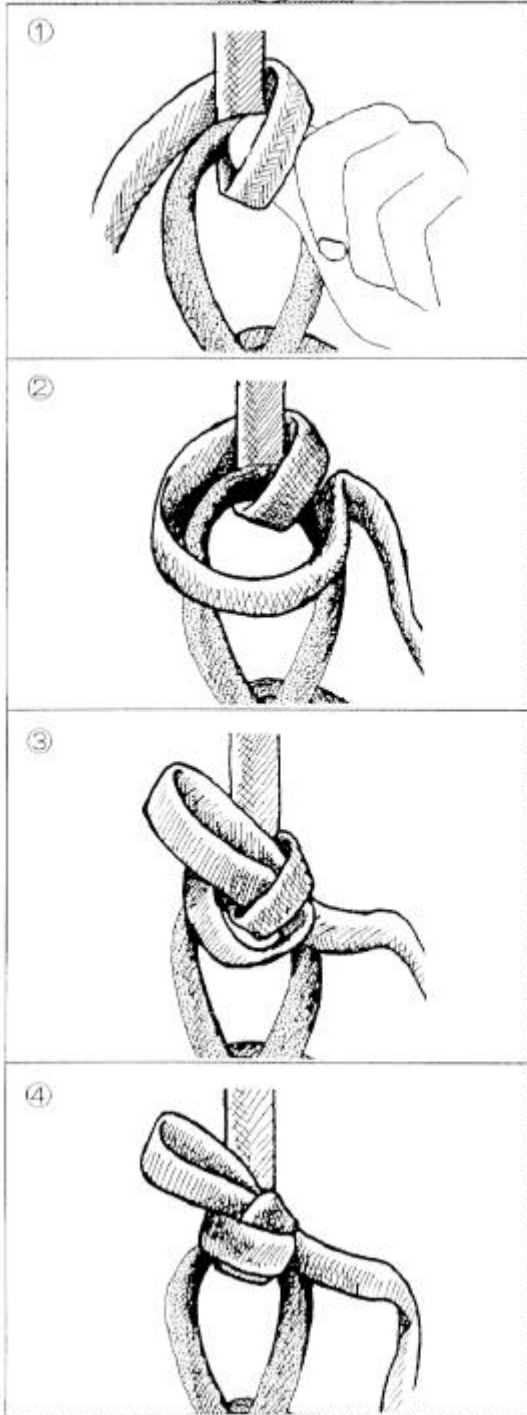

# How to tie the cords - method • B

Seen from in front

Seen from your point of view

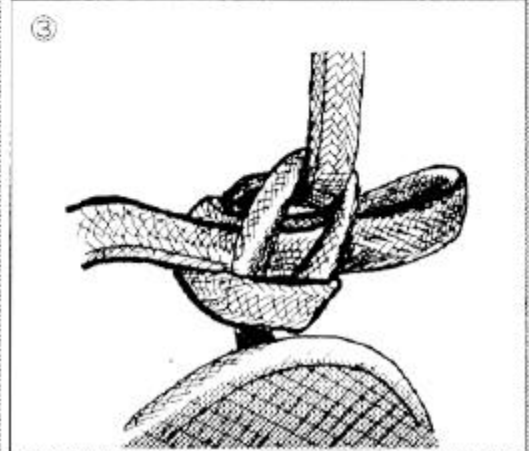
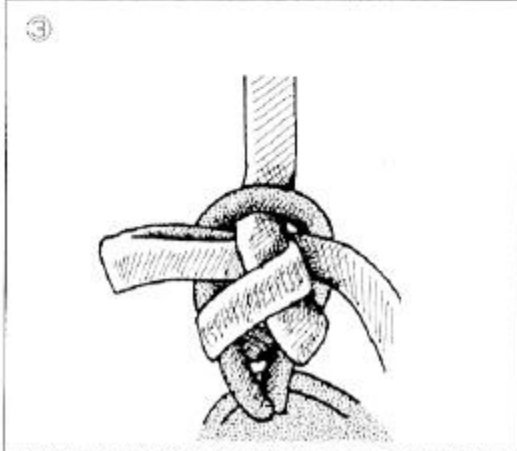
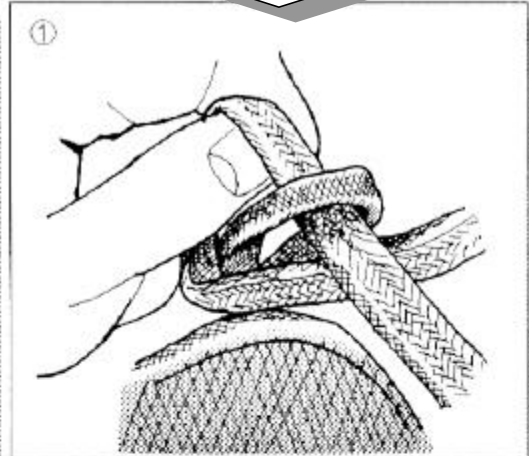
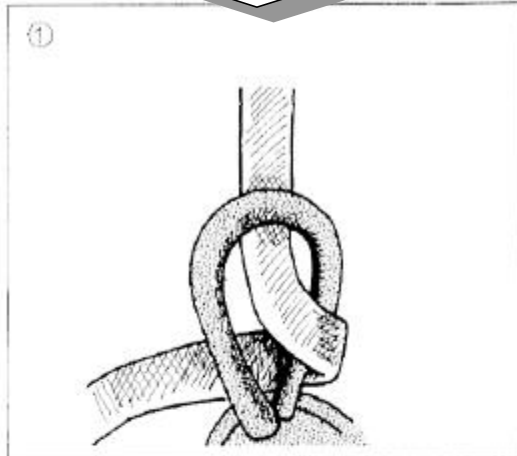

method • C

Seen from in front

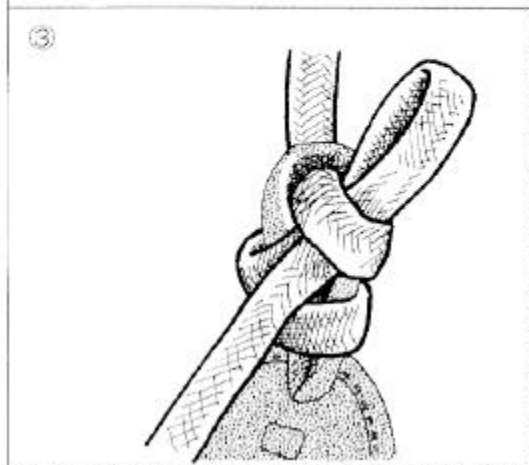
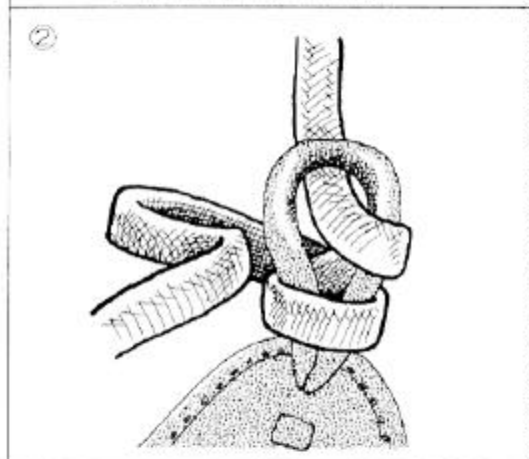
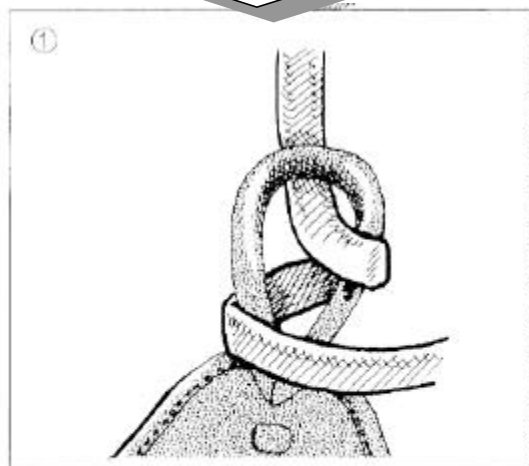

method • D

Seen from in front

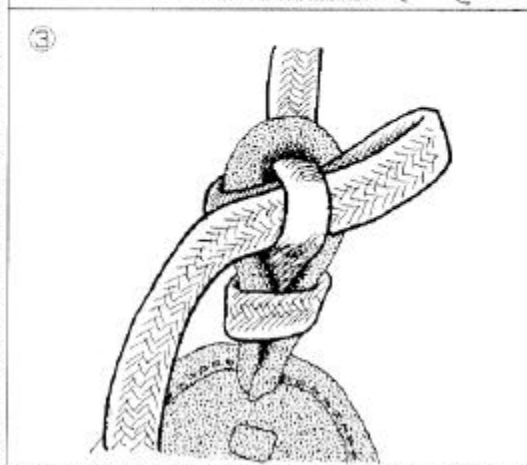
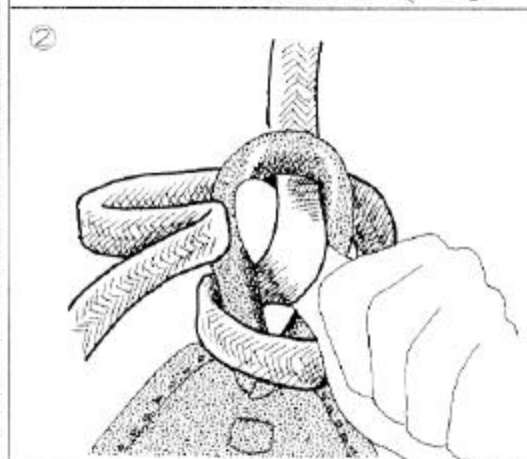
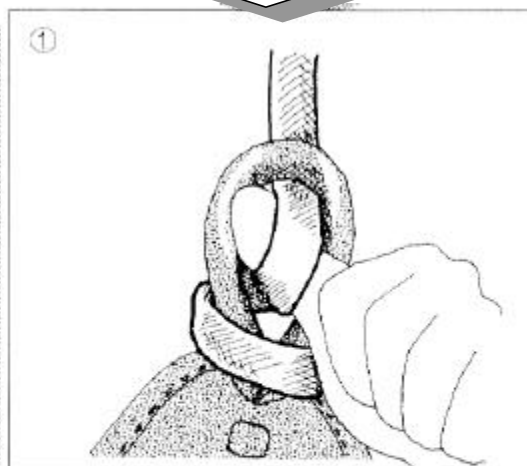



## 5 - 3 . How to keep your do well .

Salinity and the waste matter included in the sweat hurt armor. Then, after practices, the sweat must be wiped off.

Occasionally clean the decorative section (shokkou) with a toothbrush.

Beause the string and chigawa are articles of consumptions, when these are rubbing and decreasing, you change new one.

Put the tare on the do. We recommend the method of coiling them round the ends, to avoid them twisting and tearing.



(ア) Tie the do cords flatly.

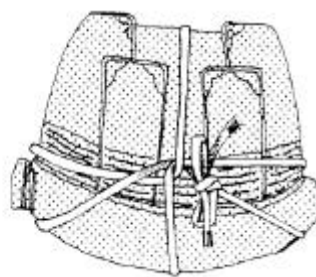

(イ) Tie the do cords loosely.

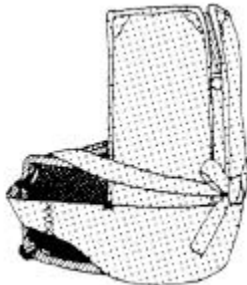

(ウ) Tie the do cords tightly.

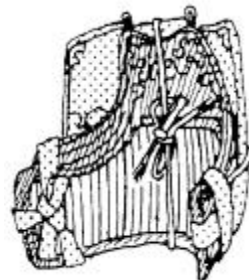

How to attach the leather loops (chichi-gawa)  
(the right and left should be mirror images).



Use an awl to widen the holes and pass the loops through.

# 6 . The men ' helmet ' 面

## 6 - 1 . The construction of the men

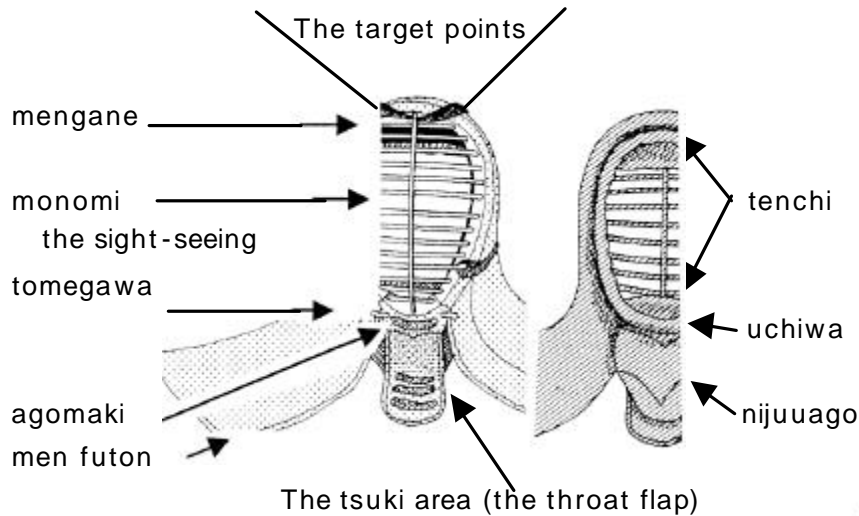

Size : Shape and the size of the head and the face are various because of the person. Then, length in surroundings to the mandible of the head in amount is measured. You order in that length. And, you actually matches and adjusts men. Back of the head does not go out so much, and Men is made the one that the positions of eyes are suitable, and fit for the sight-seeing monomi.



Material : The material of Mengane is iron, a duralumin, a stainless steel, titanium, and German silver. The protections of side are 13 in the adult for the boy 14(There are as many as 15 large-scale) usual.

The purpose of the other side's having painted red is to prevent light being reflected, and to see the outside brightly.

How to shape the men flaps.

When you just bought respect and it is not easy to move hard, shape is applied to the side bedding. About three days are diagonally folded to the way below, and binds firmly. You will come to put and never to have a pain in the god and the ear if you do like this.

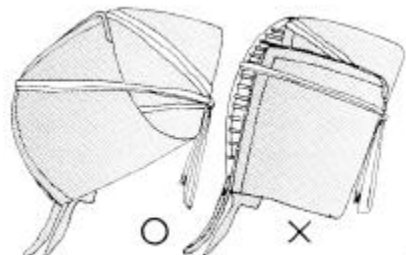

### How to connect the men chikawa

Tie the men-chichi-gawa 'leather loops' to the fourth bar(from the bottom).  
It is the third bar for childrens men which has only 13 protections.

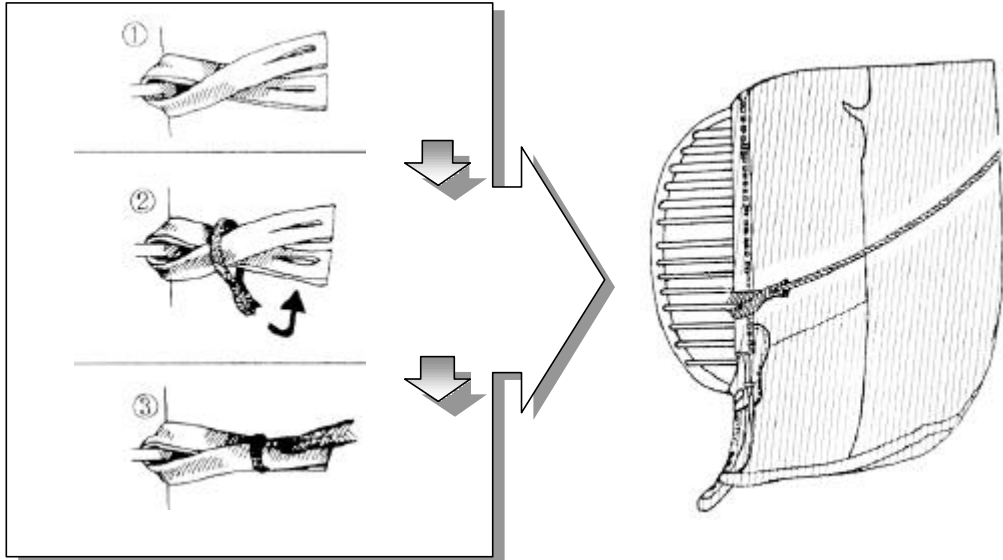

### How to make the men

The construction of the men

The men is made as follows:

- (1) Straw is wrapped around the men grill.
- (2) The chin pad is attached.
- (3) The inner frame is made.
- (4) The inner frame and men-buton are attached with strings
- (5) The inner frame and men-buton are attached with water-buffalo leather. (Water buffalo leather is soft when it is wet, so it is fastened on while it is damp and then dried.)
- (6) Finally the leather is painted with urushi lacquer to stop it from becoming damp.

Note: If you leave your men wet, the leather will swell up and distort, so it is important that you dry it after you use it.

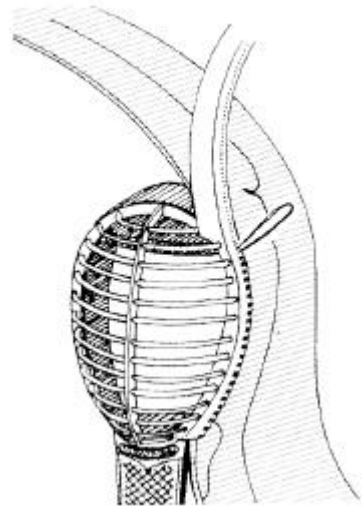

## 6 - 2 . Putting on the tenugui ' men towel '

### A . For beginners

This is the easiest method. Fold it so it fits your head exactly.

Lay the tenugui in front of you and fold it in half lengthways.

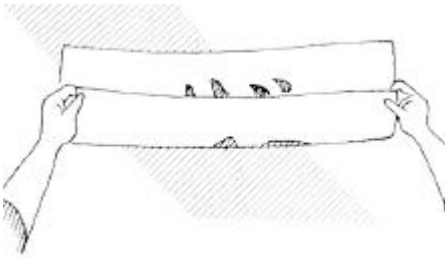

Fold it in about a third from each end.



Turn it over.

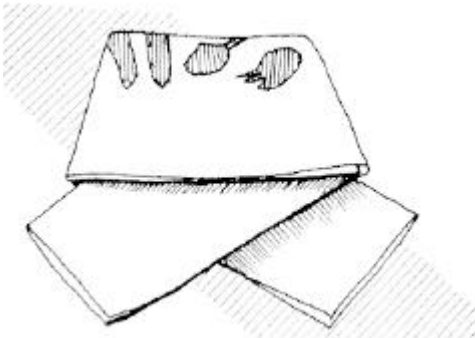

Insert the corners into the doubled over central section.

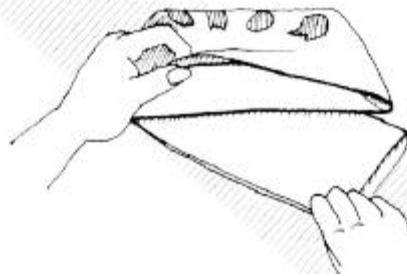

Put it on, with the thick side facing the front.

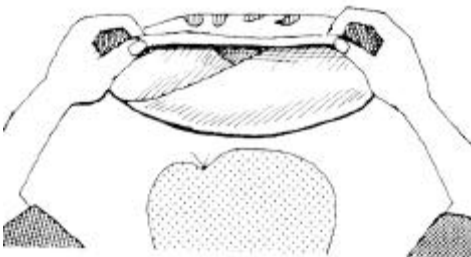

It should hide your ears, and the thick part should be on your forehead.



## B .

Fitting it exactly. Be careful not to make it too thick over your ears as it will become painful.

Hold the ends of the tenugui.



Bring the tenugui to your forehead and slide it up until the edge lies on your forehead, with your hair gathered within.



Bring the right corner of the tenugui to above and behind your left ear, holding it taut. Keep it in place with the other side of the tenugui.

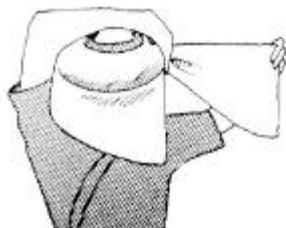

Bring the left corner round to above and behind your right ear, and tuck it in.



Lift up the flap formed in front of your face.



Your ears will be exposed.



# C .

Wrapping it around your head.

Hold both ends of the tenugui, bite the middle of the edge and draw it back over your head.



Wrap it round your head, left to right and then right to left.



Swap hands and tie the two ends in front of your forehead.



Lift up the front and tuck it in.



Pull it down on both sides.



Your ears will be hidden.



## 6 - 3 . Putting on the men

You should wear the "men" so that you can see from the monomi, the slightly wider gap between the 6th and 7th bars. If you are looking out from the monomi then your posture should be correct.

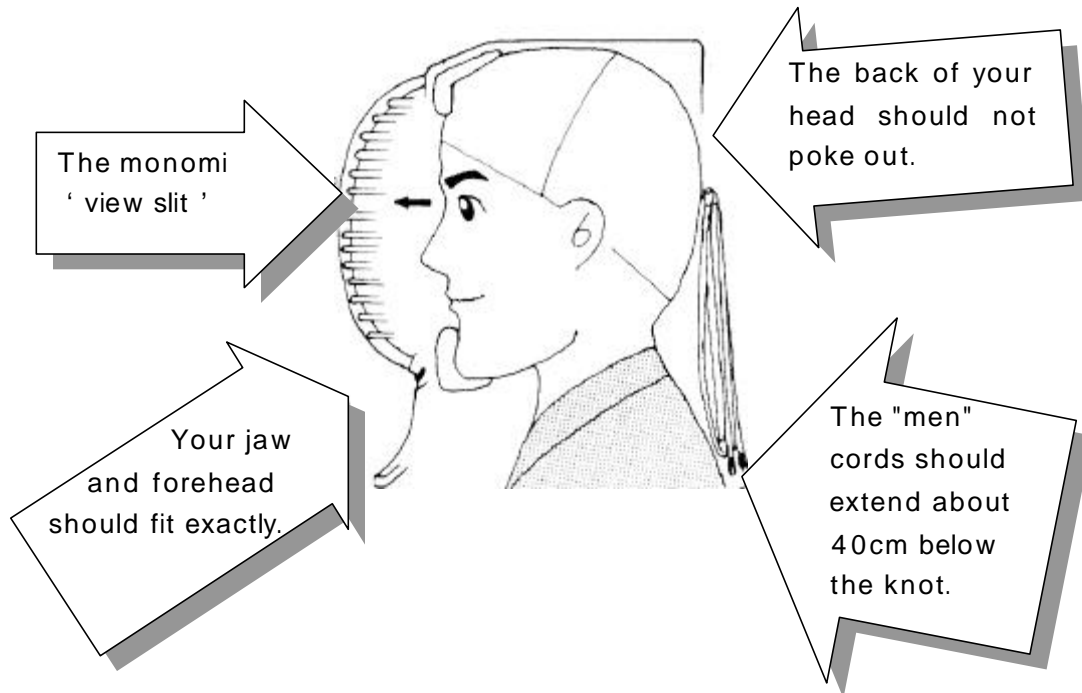

If the jaw is not stored like the right, it is dangerous. The impact comes directly to the throat, and there is danger by which back of the head is hit when falling in addition in the pain when pierced when respect is hit.



×

## Putting on the men A

Take the cords from the fourth or fifth bar of the men grill, cross them behind the men then pass them through the top bar and back behind again.

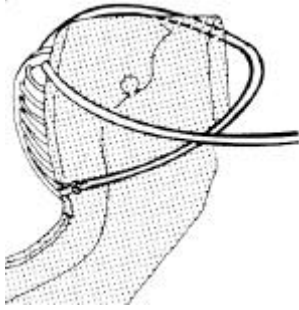

## Putting on the men B

Put your chin in and put the men on, then cross the cords, once behind your head and then in front of your jaw.

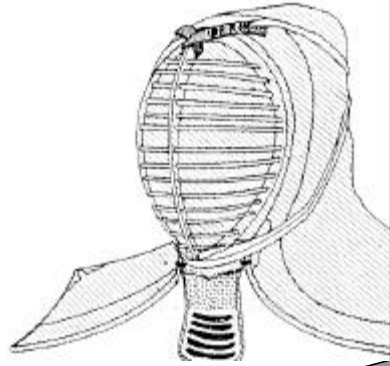

Gather the cords in your hands, open the men, put your chin in and pull it over your head.



Cross the cords behind your head once more and then pass them through the topmost bar of the men grill.

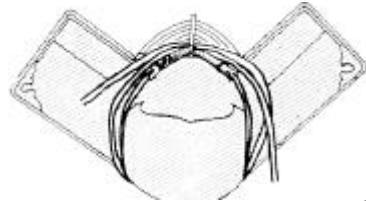

Firmly tie the cords in a bow so that the men will not twist and adjust the lengths of cords so they are even.



Firmly tie the cords in a bow so that the men will not twist and adjust the lengths of cords so they are even.





## 6 - 4 . How to keep your men well .

When you have finished using the "men", immediately wipe it with a well-wrung damp cloth and then dry it. Sweat and dirt breed germs and will smell.

Even when the outside dries it is hard to dry the inside, so you should hang it in a well ventilated place, or put newspaper or a desiccant inside.

When the cloth on the inside of men futon and the edge of men futon rubs against each other to the shoulder can thin completely, let's have Mr. protector shop apply the cloth and leather before inside cotton and the rug are seen.



### Adjusting the lengths of the men cords

Put your "men" on and tie the cords. Adjust the cords so that they hang 40cm below the knot, and then cut off any excess.

Unthread the ends for 3 or 4 cm. Take two or three of the threads and twist them into two



Wrap the two strands once round the whole cord.

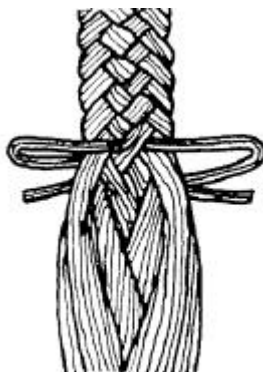

Tie them tightly and arrange them neatly.



# 7 . The kote ' gauntlets' 小手・甲手

## 7 - 1 . The construction of the kote

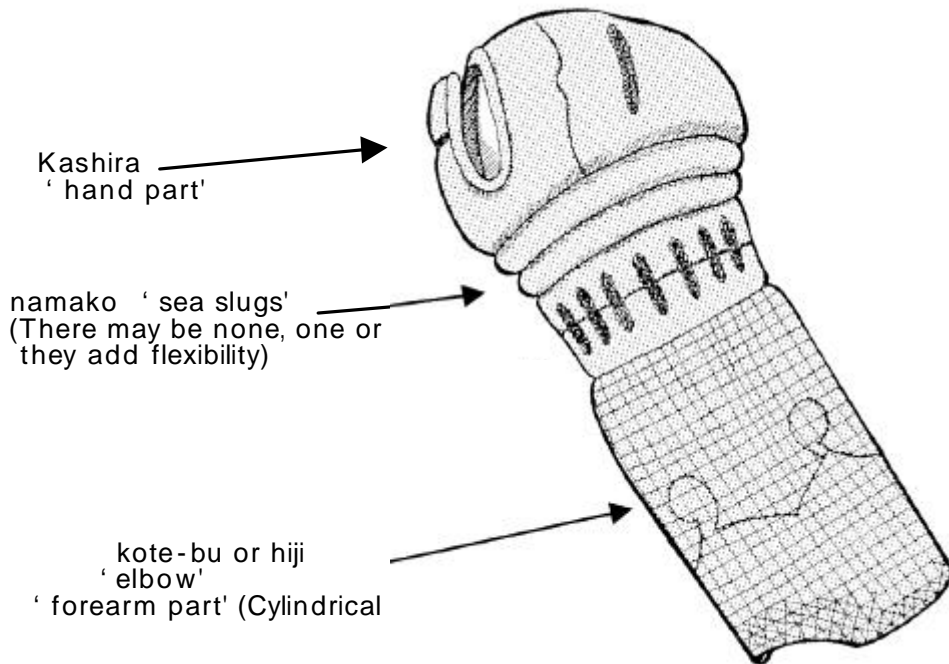

The kote is made of indigo dyed cloth and deer hide, silk (or equivalent) ornamental thread, cotton or blanket material, the hand-part is made of deer hair (or equivalent) and two cords.

**Size;** It is not easy to use when it is too large, and when it is small, can <hand> do the diligence.

**Material;** Kote is made with the hair of the deer in the decoration string of a cotton cloth of the indigo dye, deer's skin, artificial leather (clarino), and silk (or, chemical fiber), cotton, rugs (or, it is old blanket), and heads (or, chemical cotton) and two etc. small hand strings.

## 7 - 2 . Putting on the kote

Put on the kote by pushing the glove.

If you pull the forearm section you will deform the kote and hurt the joint.

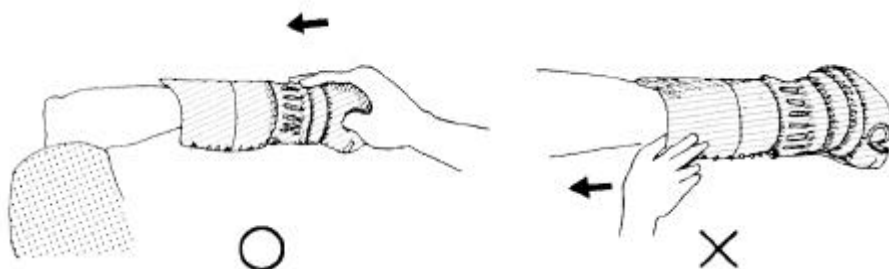

## 7 - 3 . Taking the kote off

The kote will come off easily if you push from the elbow.

If you pull beyond the joint, you will deform the kote and hurt the joint.

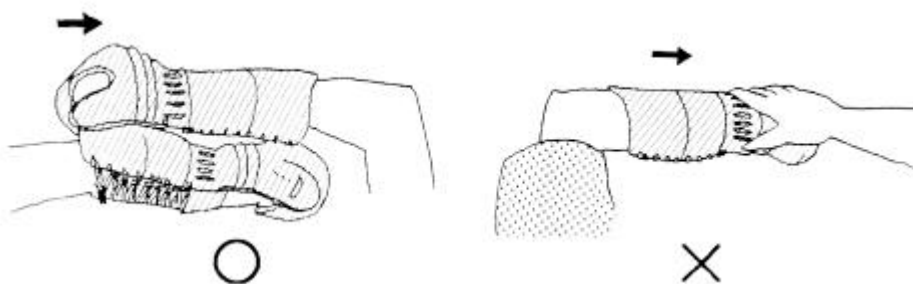

## 7 - 4 . How to keep your kote well

Sweat and dirt make the kote smell, so we recommend you dry it soon after use. ( Recently washable kote made of artificial leather and fabric have come onto the market. )

When you've finished training, stretch out the palm leather as shown in the picture and dry it. Occasionally rub it.

Like the men, the interior of the kote is hard to dry. You should hang it in a well ventilated place, or put newspaper or a desiccant inside.



## 7 - 5 . Tying the kote cords

Wind about 3cm of scotch tape to the end of the cord and make it into a point.

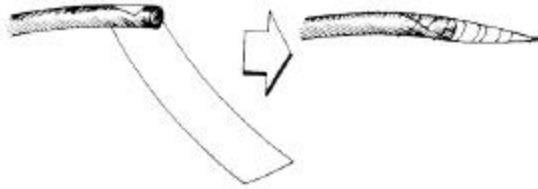

Start to thread. First pass the cord from the outside nearest the elbow and tie off the end.

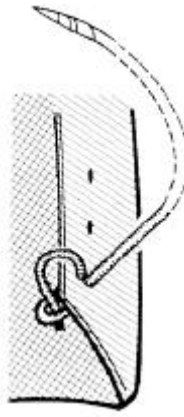
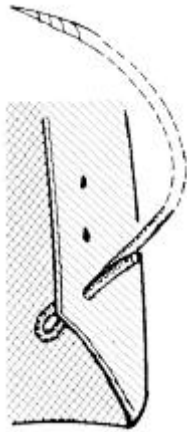
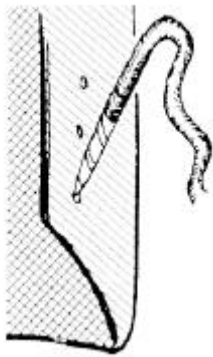

Threading the cord from the outside, make a series of loops.

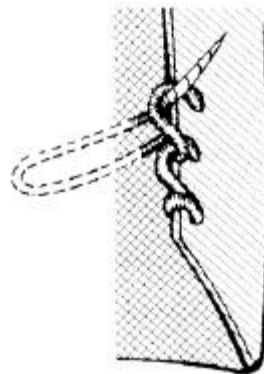
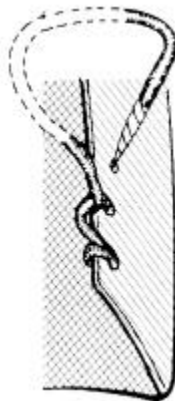
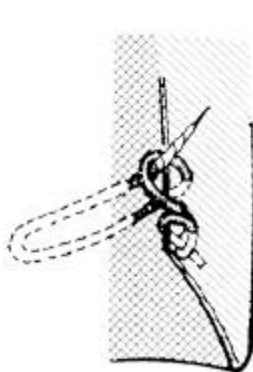

次のページへ

The knot that joins the forearm part to the hand part.

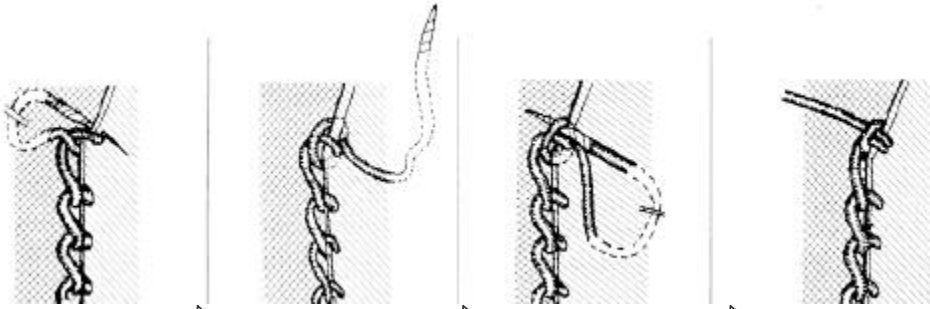

symmetry

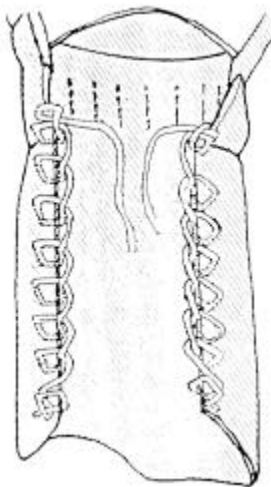

Lace the cords like a shoelace.

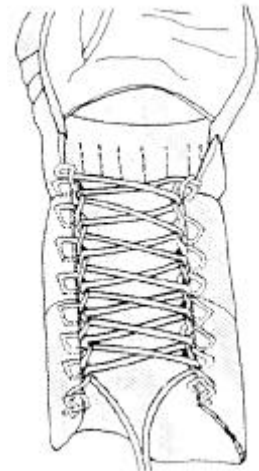
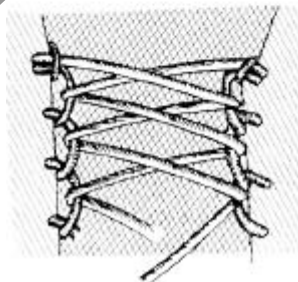
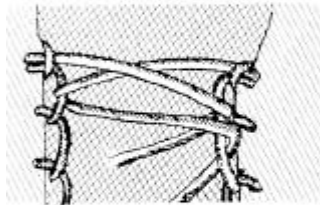
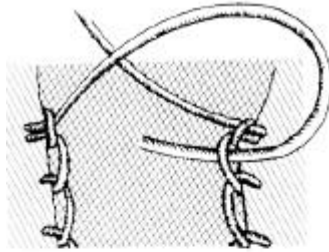

The finishing touches

Gather the two cords together.

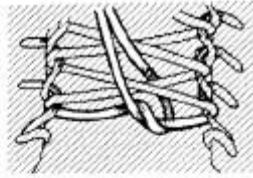

Tie each cord to the other.

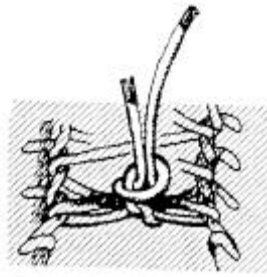
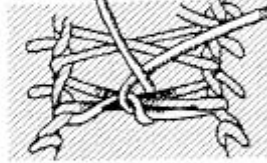

Retie them to each other.

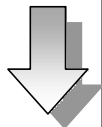
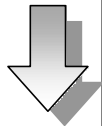
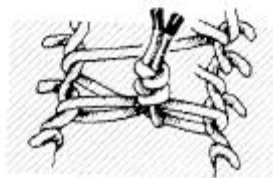
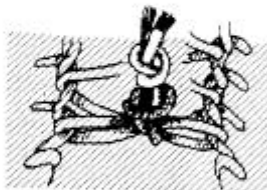
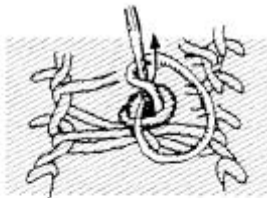

## 8 . The equipment bag 防具袋

### 8 - 1 . The construction of the equipment bag

The carrying bag is for carrying your gear, not storing it. If you need to leave the gear in for a while then you should use newspaper and desiccants to help keep it dry, and you need to be careful of mold.

### 8 - 2 . Putting the gear in

Fold the "hakama" and lay them on the bottom.

Wrap the "tare" round the "do" and put them in.

Put the "men" in.

Put the "kote" in.

Fold the "kendogi" and put it in.

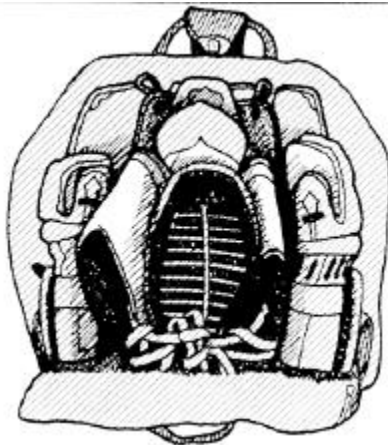

### 8 - 3 . Taking the gear out

Take out the kendogi and kote.

Put the kote in front of and to the right of your right knee and then put your men on them.

Spread the tenugui on top of the men.

Take the do out and place the tare so your name faces the front, and take your hakama out.

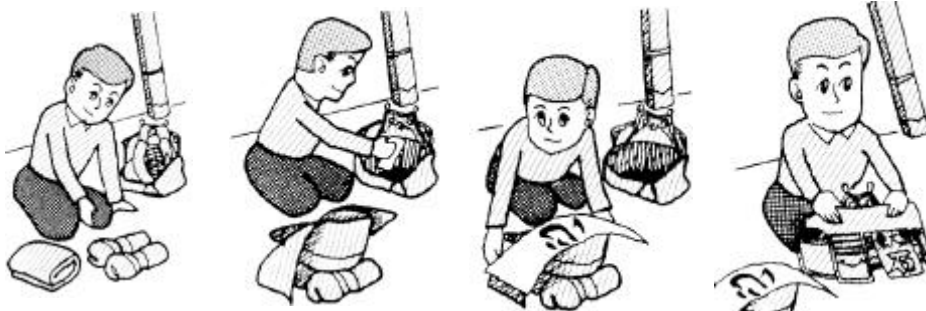

Note: The "kote" can face forwards or sideways or even be placed in front of your left knee, depending on the custom where you practice.

## Hanging up your gear

Q: What is the leather loop on the back of the do for?

A: As shown in the diagram below, the men cords can be looped so as to make the men easy to carry and hang up. In the old days, the gear was hung from the ceiling of the dojo and special windows were opened to let the wind blow over it.

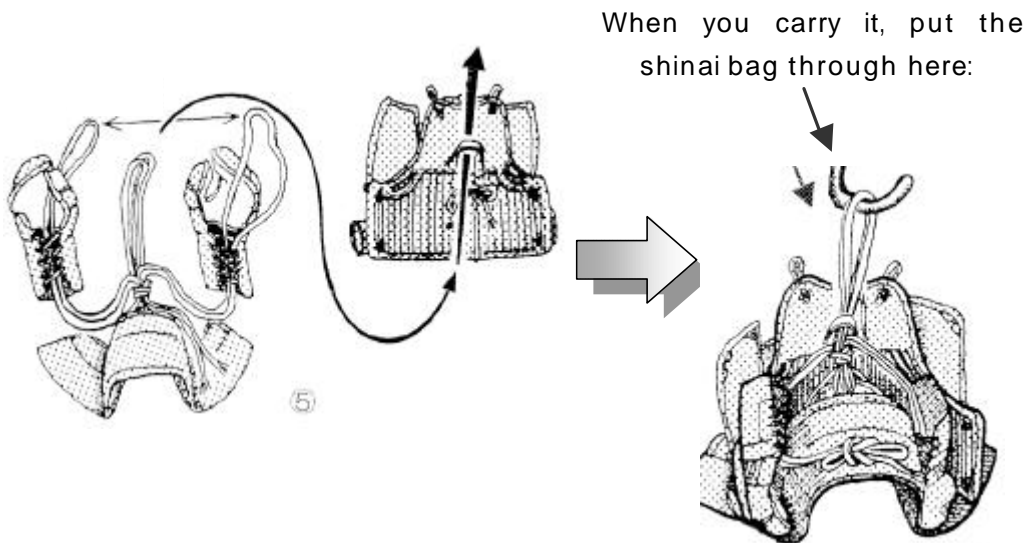
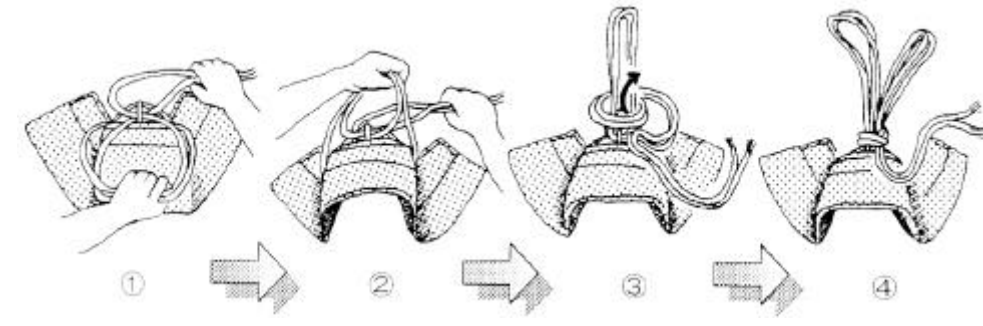

Note: Some people loop the cord round the kote's hand part, but it damages them.



## 9. Glossary

Names or words	Explanations or notes	page
Bokuto or bokken	wooden sword	17
chichi-gawa	leather loops	27,28,33,35
chigiri	small iron plate in the shinai handle	10
do	breastplate	27
do-yoko-chichi-gawa	side leather loops(of the do)	27,28
dodai	do plate	27
dojo	training hall	48
ha	blade	17
hakama	trousers	21
haraobi	gut belt	25
hiji	elbow	42
himo	cord, sash or string	41,44
jinbu	blade	17
kanji	Chinese characters	
kashira	hand part (of the "kote")	17
katana	Japanese sword	17
kawa-himo	leather loop (on the hilt leather)	12
keichiku	a kind of bamboo (that grows in warm areas)	6
keikogi	training jacket	18
kendogi	training jacket	18
kensen	sword tip	5
kissaki	sword tip	17
komono	small leather loop (on the tsuru)	13
koshi-ita	back plate (of the hakama)	21
kote	gauntlets	42
kote-bu	forearm part (of the kote)	42
men	helmet	34
men-buton-bu	the men futon area	34
men-chichi-gawa	leather loops (on the men)	34,35
men-gane	men grill'	34
madake	one of Japanese bamboo (Phyllostachys bambusoides)	6
mine	back of blade	17
mono-uchi	cutting area (of the shinai)	17
monomi	the wide gap (in the men grill)	34
mosochiku	a thick-stemmed bamboo (Phyllostachys pubescens)	6
nakayui	leather thong' (on the shinai)	15
namako	sea slugs (on the kote)	42
ootare	big flap	25
ni-tou	two swords	5
saburoku	3-shaku 6-sun shinai'(111 cm)	5

saki-gawa	leather tip	11
saki-gomu	rubber tip	8,11
san-nana	3-shaku 7-sun shinai'(114cm)	5
sanku	3-shaku 9-sun shinai'(120cm)	5
sanpachi	3-shaku 8-sun shinai'(117cm)	5
seiza	formal kneeling position	29
shaku	old Japanese unit 30.3 cm (10-sun)	5
shinai	bamboo sword	5
shinogi	line through tip area	17
shokkou	decorative section (on the do and men-tare)	28
sun	old Japanese unit: 3.03 cm	5
tare	waist armor	25
tenugui	men towel	36
tsuba	guard	5,16
tsuba - dome	guard stop	5
tsuka	hilt	5
tsuka-gashira	pommel	5
tsuka-gawa	hilt-leather	5
tsuki	throat target area	34
tsuki-tare-bu	the throat flap	34
tsuru	cord (on the shinai)	5,8,12

# In conclusion

To do kendo safely, it is important to that your "shinai" and armor are kept in good condition through regular maintenance. Unless the kendo player (or the parents of young children) understand how the equipment is constructed and how to look after it it can be dangerous.

But kendo equipment doesn't come with a manual, unlike most things in today's world. Therefore we have written an easy to understand, illustrated manual to help kendo players can maintain their own equipment.

Kendo is something you need to learn, where you receive instruction from teachers and seniors. From that point of view, there is no need for a manual. However we think this manual will be worth it if it helps to make kendo safer.

We hope this manual is useful to kendo players everywhere.

First Japanese edition 1 Jul 1994  
Second Japanese edition 1 Oct 1994  
Third Japanese edition 1 Jul 1998  
Second English edition 1 July 2001  
Author/Illustrator Yasuji Ishiwata  
Author/Translator Francis Bond and Yasuji Ishiwata  
Address enquiries to the publisher:Fukuda Kikaku  
2-6-43 Honcho, Asaka-shi, Saitama-ken, Japan 351-0011  
TEL(048)465-5771 FAX(048)465-9370  
E-Mail : budogu@big.or.jp  
[http://www6.big.or.jp/~ budogu](http://www6.big.or.jp/~budogu)  
Reproduction strictly prohibited.

We want to advocate expanding kendo and to make kendo safer. We don't intend to get money. It costs too much money to publish this book. So, this book is not published and not sold. But you can see at internet. Please not copy for sale.